

PaceMaster

Silver Select XP



OWNER'S MANUAL

Manufactured by: Aerobics Inc., 34 Fairfield Place West Caldwell, NJ 07006, (973) 276-9700

www.pacemaster.com

Part # TMP1627

Rev. 09/01/09

TABLE OF CONTENTS



INTRODUCTION	3
IMPORTANT SAFETY INSTRUCTIONS	4
ASSEMBLY INSTRUCTIONS	5-15
Unpacking Your Treadmill	5
Installation Requirements	6
Tools Required for Assembly	6
Grounding Instructions	6
Assembly	7-14
Testing Your Treadmill	15
THE PACEMASTER SILVER SELECT XP CONTROL PANEL	16-18
OPERATING INSTRUCTIONS	19-28
Metric Units	19
Setting Your Weight and Age	19
Warm Up and Cool Down	19
Quick Start	20
Timed Workout (Manual)	21
Programs	22-27
P1	22
P2, P3, P4, P5, and P7	23
P6	24
P8 and P9	24-26
Program Specifications	27-28
HEART RATE	29-31
Monitoring your Heart Rate	29
Heart Rate Programs (H1, H2, and H3)	30-31
EXCLUSIVE PACEMASTER FEATURES	32-33
Exercise Preview	32
Aerobic Points	32
Personal Electronic Trainer	32-33
CARE AND MAINTENANCE	34
Deck and Tread Belt Cleaning	34
Lubrication	34
Centering the Tread Belt	34
Cup Holder	35
TROUBLE SHOOTING	36-39
Electronic Error Codes	36-37
Noises	38
Hesitation of the Belt	38-39
Drive Belt Tension Adjustment	38-39
Tread Belt Tension Adjustment	39
FREQUENTLY ASKED QUESTIONS	40
PACEMASTER TECHNICAL SPECIFICATIONS	41

INTRODUCTION

Congratulations and thank you for choosing PaceMaster – your partner in achieving your fitness goals and mastering your well-being. PaceMaster’s advanced digital technology allows your treadmill to process information instantly, anticipating and adjusting to meet your needs. Think of it as your own personal trainer.

PaceMaster’s superior components and US manufacture ensure we produce treadmills of the highest quality while also offering excellent value for your dollar. PaceMaster treadmills have consistently received praise from a wide range of nationally recognized publications.

To get the most from your PaceMaster, please read this owner’s manual carefully before starting to use the treadmill. The manual contains important information about the assembly, operation and maintenance of the machine.

Please ensure you read and fully understand all safety information.  **DANGER**,  **CAUTION**, or  **WARNING** indicates important safety warnings throughout the manual. Failure to read and understand these warnings may result in personal injury or damage to your treadmill.

Tip: indicates a useful suggestion when installing, maintaining or using your treadmill.

Your PaceMaster treadmill is capable of varying your workout by changing speed, incline and time. It can also measure the effect of your workout in a number of different ways. For example “Aerobic Points” (see page 32) is a well tested method to set workout goals based on a desired level of overall fitness. Your PaceMaster treadmill can automatically calculate Aerobic Points for you. In this way your treadmill acts like your own personal trainer.

Please take the time to familiarize yourself with the range of functions available. This will help you work with your PaceMaster treadmill for maximum efficiency to achieve your fitness goals and master your well-being.

We wish you an enjoyable and rewarding partnership with your PaceMaster treadmill.

This treadmill is in compliance with EN 957-2 class H.

The PaceMaster Silver Select XP treadmill is designed for home use only.

IMPORTANT SAFETY INSTRUCTIONS

Read these instructions before using your treadmill

 **CAUTION:** Before starting any exercise program, contact your personal physician and have a complete physical. This is highly recommended if you have not been on a regular exercise program within the last year, or are over 35 years of age, or are overweight.

 **CAUTION:** If at any time during your exercise program you find the exercise abnormally difficult or you encounter dizziness, feel faint, experience chest pains, feel as if your heart may be skipping beats, you experience forced heavy breathing after minimal exercise or severe pain in your legs, ankles, knees, etc. STOP EXERCISING and consult your physician.

 **WARNING:** To reduce the risk of burns, fire, electrical shock or injury:

- Never operate your PaceMaster treadmill without clipping the magnetic safety key to your clothing at waist level.
- Your PaceMaster treadmill is not designed for use by children under the age of 18 without strict parental supervision.
- Close supervision is necessary when the treadmill is used by or near children, disabled persons or pets.
- Use your PaceMaster treadmill only for its intended use as described in this manual. Do not use accessories or attachments not recommended by Aerobics, Inc.
- Never operate your PaceMaster treadmill if it has a damaged cord or plug, if it is not operating properly, if it has been dropped or damaged or if it has been immersed in water. Should any of these occur, contact your authorized PaceMaster retailer or service center for examination or repair.
- Keep the cord away from heated surfaces.
- Never drop or insert any object into any opening on the treadmill.
- Do not use outdoors.
- Always unplug your PaceMaster treadmill during an electrical storm or during extended periods of non-use.
- Do not operate where aerosol (spray) products are being used or where oxygen is being administered.
- Position the treadmill with a minimum of 4 feet (1219mm) of clearance between the rear of the treadmill and any wall or obstruction.
- Do not allow anyone to reach under or be too near your PaceMaster while it is in use.
- Do not attempt to mount or dismount the tread belt while it is running.
- Never allow more than one person on your PaceMaster treadmill at any time.
- Never move the treadmill while it is plugged into the electrical outlet.
- When you are finished exercising, leave your PaceMaster treadmill in a non-elevated position to avoid toys and other objects from becoming trapped beneath.
- Wear appropriate running or walking shoes and attire while exercising.
- The treadmill should be turned off after each use by removing the safety magnetic key.

ASSEMBLY INSTRUCTIONS

Unpacking Your Treadmill

Confirm that all of the items pictured below were packed in the box

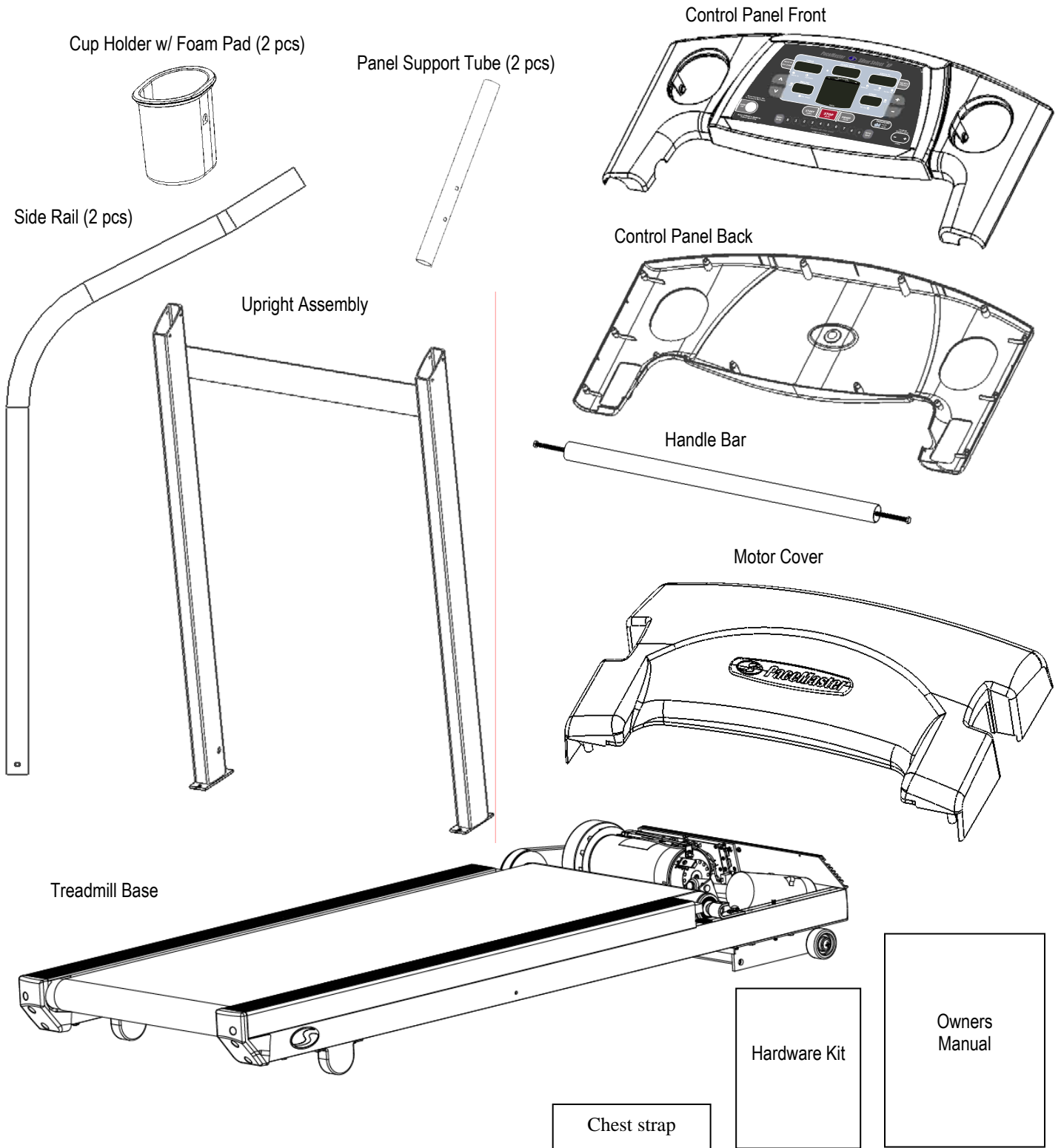

Before assembling your treadmill, open the hardware package and verify that the contents of the package match the hardware legend included in the hardware package. If any parts are missing, contact the authorized PaceMaster retailer where you purchased your PaceMaster treadmill.

ASSEMBLY INSTRUCTIONS (cont'd)

Installation Requirements

Your PaceMaster should be installed indoors on a flat, level surface near a 120Volt/ 15Amp outlet. PaceMaster requires a dedicated, non-switched outlet that is not part of a GFI (Ground Fault Interrupter) circuit, preferably no more than 5 feet from the outlet to eliminate the need for an extension cord. You must have a minimum of 4 feet of clearance between the rear of the treadmill and any wall or obstruction.

TIP: If you are installing your PaceMaster on a carpeted surface, use a treadmill mat or a scrap piece of carpet underneath the treadmill to avoid soiling of the carpet. Deep pile carpet is not recommended.

Tools Required for Assembly

- 3/16" Allen wrench (supplied)
- 7/16" combination wrench (2X)
- Phillips head screwdriver
- Slotted Head Screwdriver

Grounding Instructions

⚠ DANGER: This product must be properly grounded. If it should malfunction or become inoperable, grounding provides a path of least resistance for electric current to reduce the risk of electric shock. This product is equipped with a cord having an equipment-grounding conductor and a grounding plug. The plug must be plugged into an appropriate outlet that is properly installed and grounded in accordance with all local codes and ordinances. See example to the right.

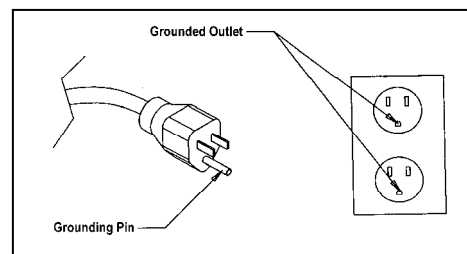

⚠ WARNING: Improper connection of the equipment grounding-conductor can result in a risk of electrical shock. Check with a qualified electrician or serviceman if you are in doubt as to whether the product is properly grounded. Do not modify the plug provided with the product. If it will not fit the outlet, have a proper outlet installed by a qualified electrician. This product is rated for more than 15 amperes and is for use on a circuit having a nominal rating of 120 volts. It is factory equipped with a specific electric cord and plug to permit connection to a proper electric circuit. Make sure that the product is connected to an outlet having the same configuration as the plug. **No adapter should be used with this product.** Attempting to bypass it with an adapter or in any way defeating its purpose can result in a serious shock hazard.

As a safety precaution, unplug the treadmill during electrical storms or if the treadmill will not be in use for periods greater than one week.

⚠ CAUTION: If you need to use an extension cord it must be a 14 gauge, three wire cord, no longer than 12 feet.

ASSEMBLY INSTRUCTIONS (cont'd)

Step One:

Carefully place the bottom of the upright (1) on the frame (2) so the two holes in the plate at the bottom of the upright line up with the holes in the frame.

Insert the 3.5" carriage bolts (3) through the upright and the frame.

Loosely install a 1/4-20 kep nut (4) to each carriage bolt to keep the upright in place. Follow the same procedure for the other side of the upright. Do not tighten any nuts until Step Ten.

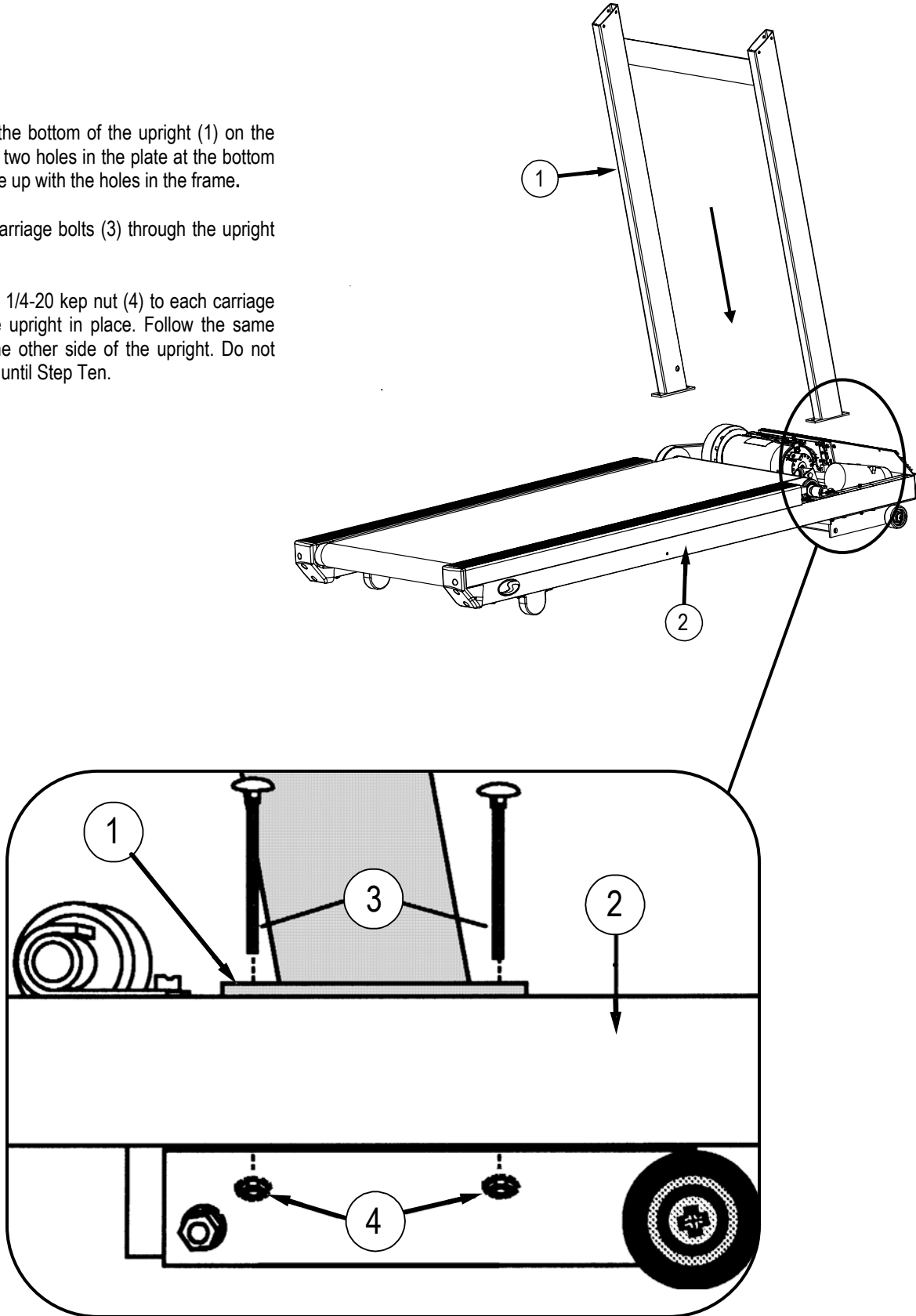

ASSEMBLY INSTRUCTIONS (cont'd)

 **CAUTION:** Make sure the treadmill is NOT plugged into the electrical outlet until assembly is completed.

Step Two:

With the upright loosely bolted in place, plug the black wire harness (5) into the socket (6) on the power supply board. Twist open the purse clip at (7a) insert the wire harness (5) and secure the purse clip (7b).

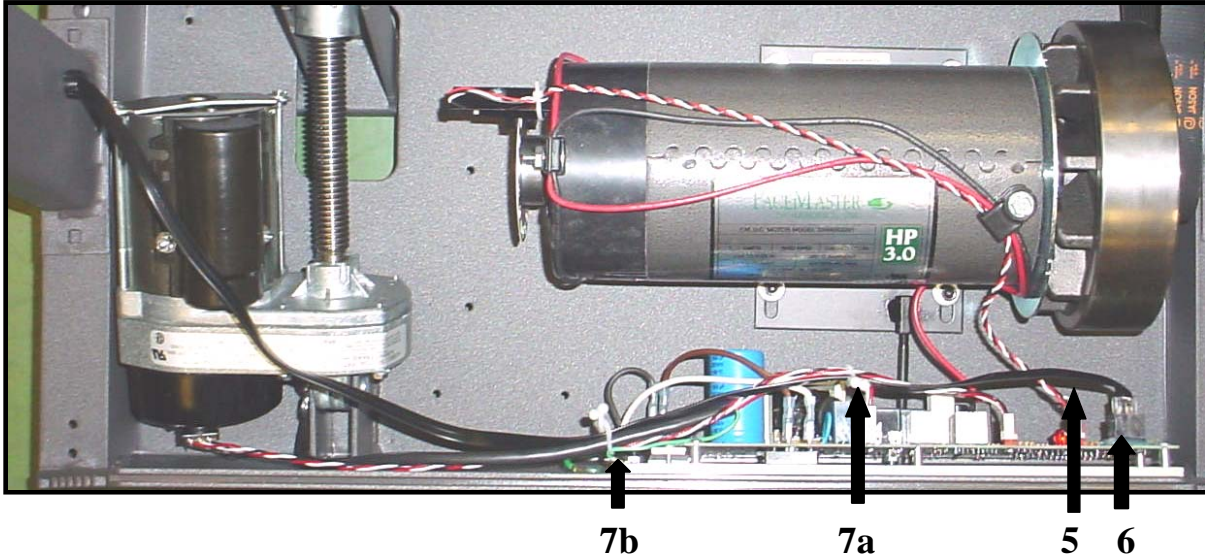
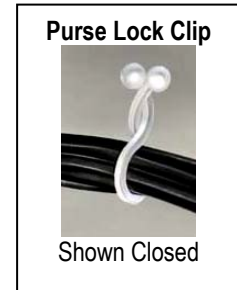

Step Three:

Route the wire harness (8) through the opening in the back of the control panel (9), then lower it on to the upright and let it rest as shown in the drawing.

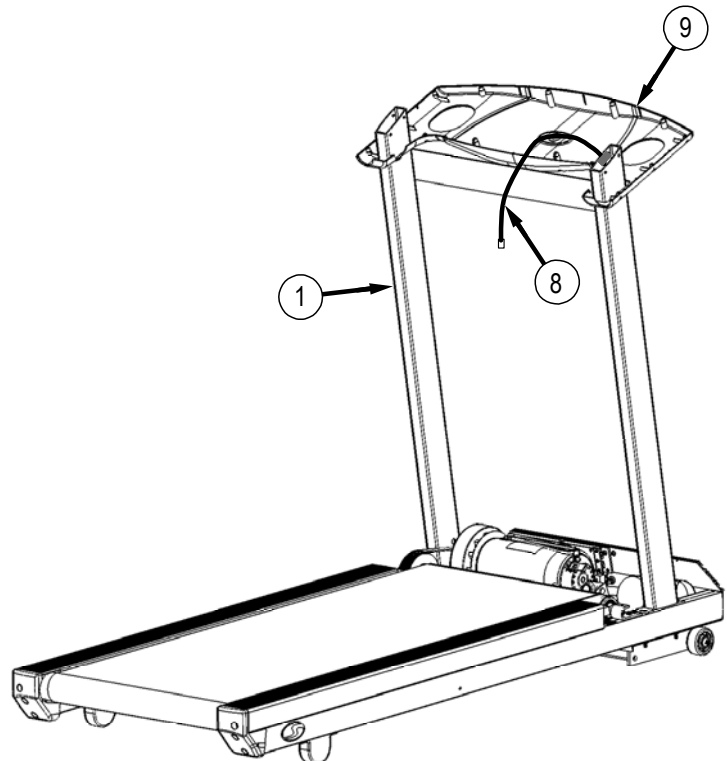

ASSEMBLY INSTRUCTIONS (cont'd)

Step Four:

A. Remove the 3.5" Hex bolts (10) from both ends of handle bar (11). See FIG. A1. Place the Handle Bar (11) between the uprights (2) as shown in FIG. A2.

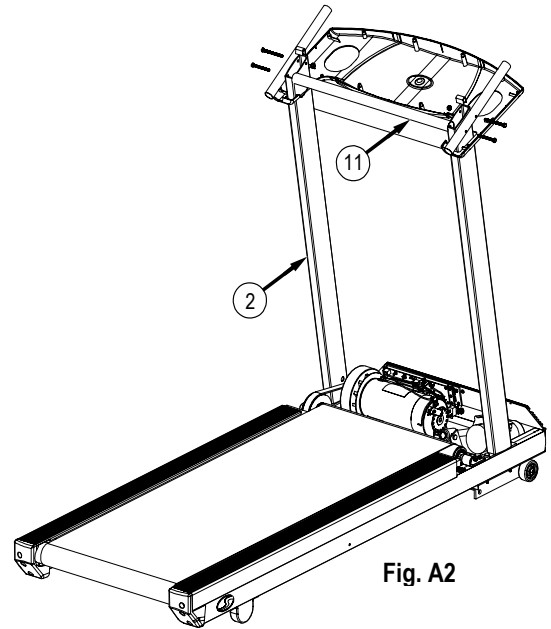
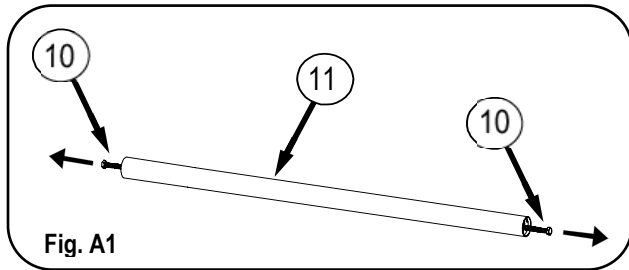

B. Using the 3.5" Hex bolt (10), loosely screw together the panel support tube (12), the upright (2), and the handle bar (11). See FIG. B. Follow the same procedure on the opposite side.

Using the 3" hex bolt (13) and a 1/4-20 kep nut (14) loosely screw together the panel support tube (12) and the upright (2). See FIG. B. Follow the same procedure on the opposite side.

Make sure wire harness (8) is routed between bolts (10) and (13). See FIG. B.

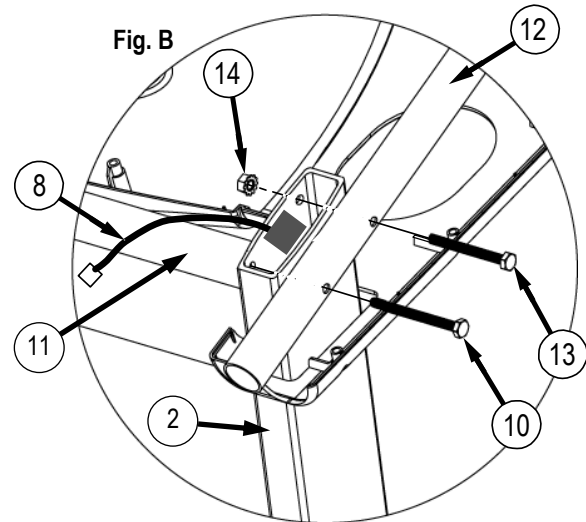

C. Place spacer (15) in the upright on top of bolt (13) on both sides. See FIG. C. Proceed to securely tighten all 4 bolts.

NOTE: If spacer (15) is dropped into the upright (2) then upright must be removed in order to retrieve the spacer. If spacer is not retrieved it will make noise when machine is in use.

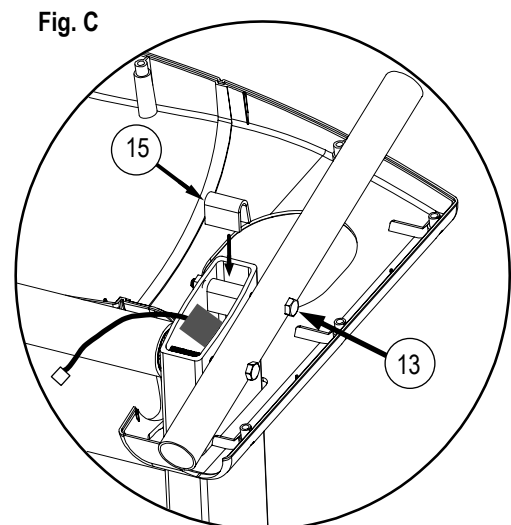

ASSEMBLY INSTRUCTIONS (cont'd)

Step Five:

Lower the top of the control panel (16) on to the upright assembly as shown below

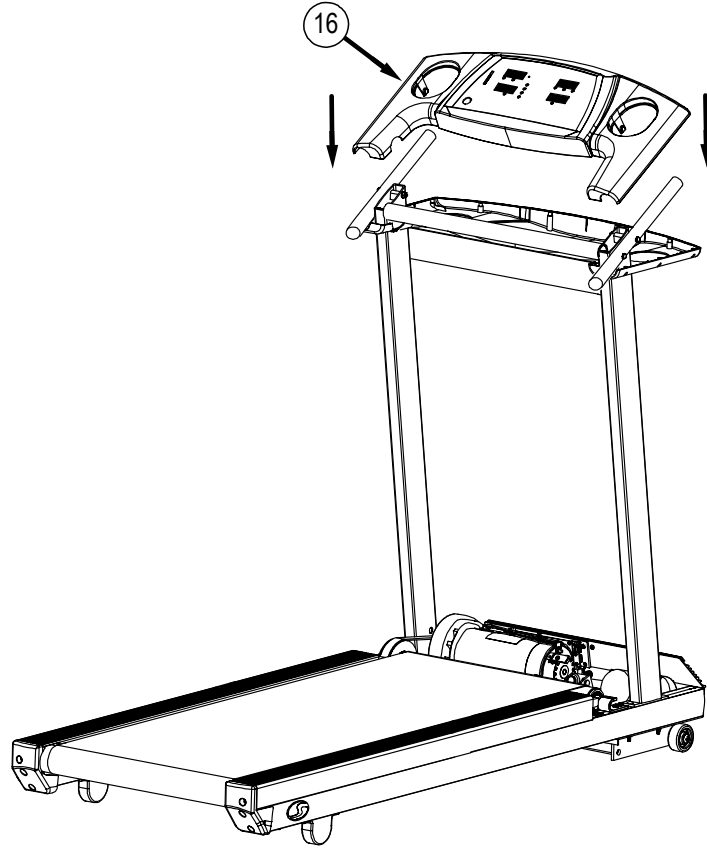

Step Six:

Route the wire harness (8) as shown below. Pull the wire harness taut then apply tape #1 exactly as shown. Repeat and apply tape #2 exactly as shown. Harness must be **flat** against the side wall of the black plastic housing between tape#1 and tape #2. Plug the end of the wire harness into the connector on the circuit board. All the slack in the wire harness should be near the connector.

NOTE: Wireless heart rate will not work if these instructions are not followed.

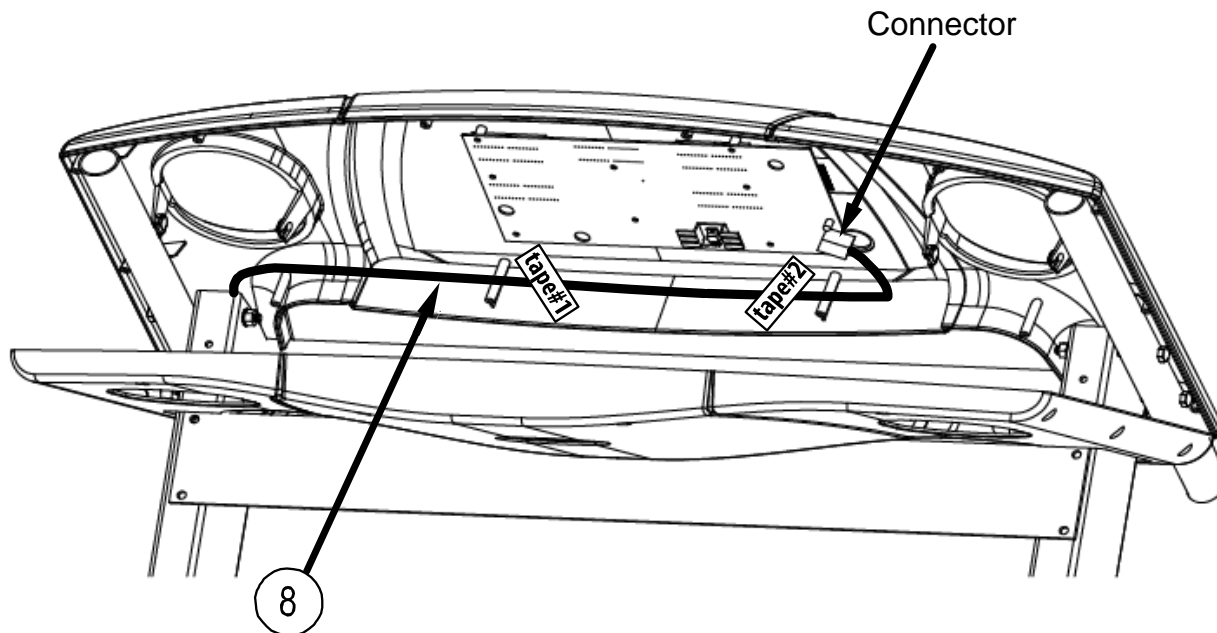

ASSEMBLY INSTRUCTIONS (cont'd)

Step Seven:

Screw together the two halves of the control panel using the 14 one inch pan head screws (17). Start with the screw labeled 17 and proceed in a clockwise tightening sequence.

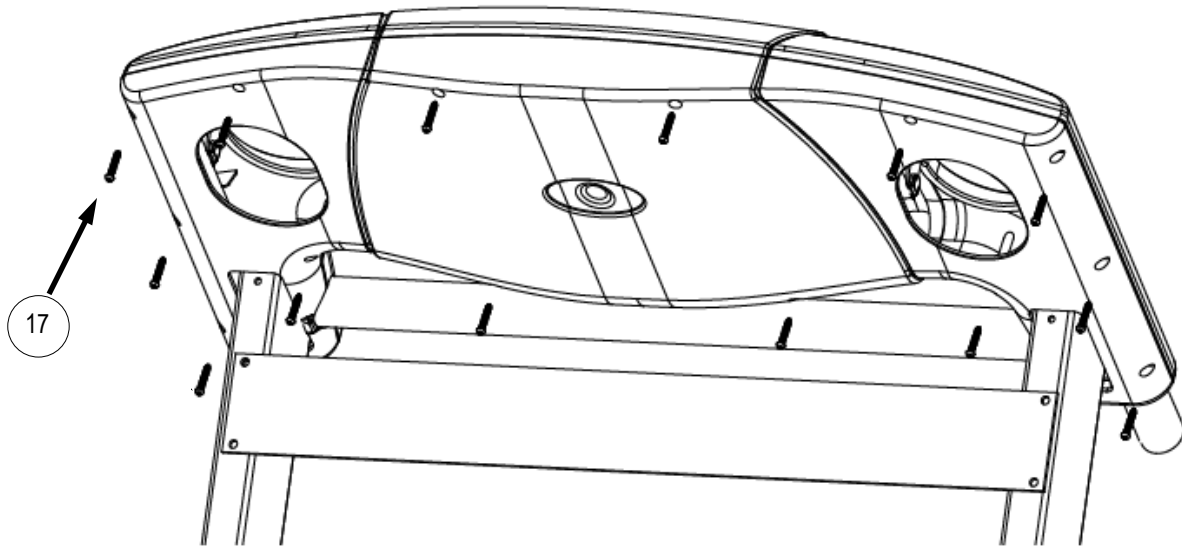

Step Eight:

Insert side rail spacer (18) onto the black panel support tube (12). Slide side rail (19) over the spacer. Repeat procedure on opposite side of the machine.

Note: Make sure the siderail (19) slides all the way into the panel.

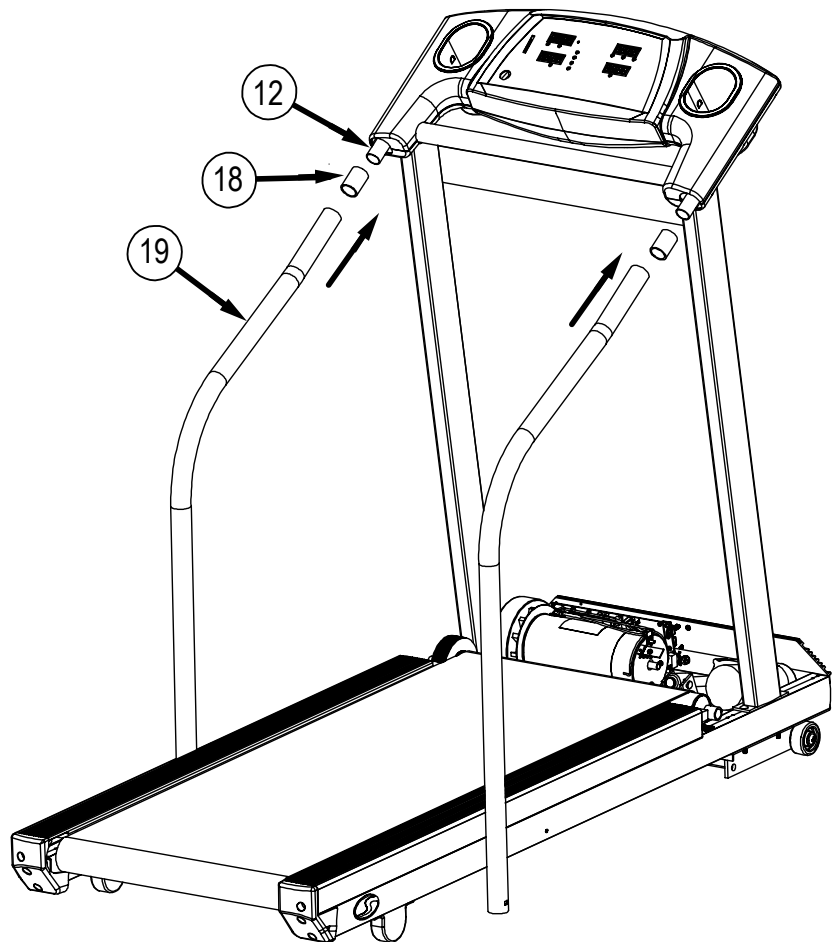

ASSEMBLY INSTRUCTIONS (cont'd)

Step Nine:

Insert one of the 4" slotted head bolts (20) through the side rail (19), the side rail bracket (21) (the foam on the bracket should be at the top, facing the frame) and finally through the frame (2). Install a 1" fender washer (22) and a 1/4-20 kep nut (4) to the bolt and hand tighten. Install the other side rail following the same procedure. Tighten both side rails with a 7/16" wrench.

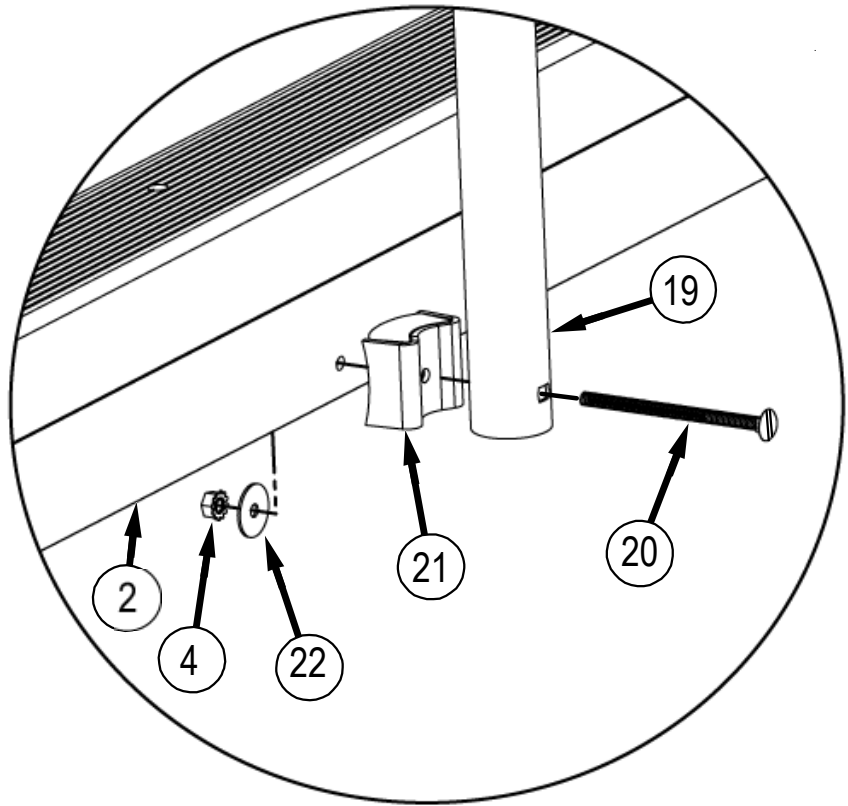

Step Ten:

Tighten the 4 1/4-20 kep nuts (4) installed in step one.

These will secure the upright assembly

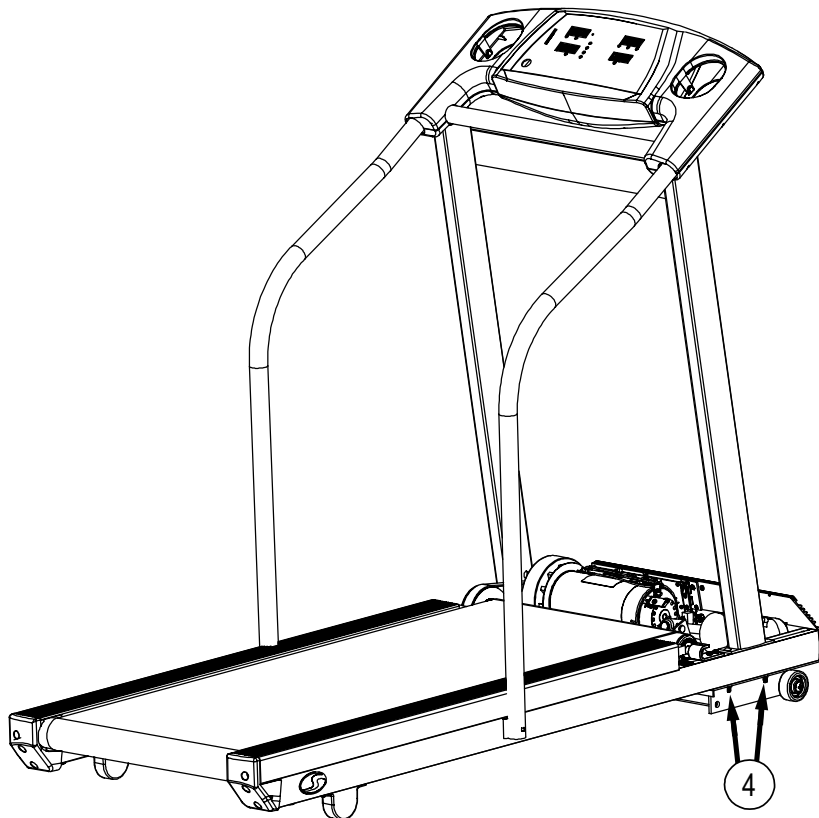

ASSEMBLY INSTRUCTIONS (cont'd)

Step Eleven:

Insert the cup holder (23) into the hole in the control panel (16). Push down until you hear and feel it firmly snap in place.

Note: The cup holder should sit flush to the control panel when it is snapped in place. If not, remove cup holder and rotate 180 degrees, then reinstall.

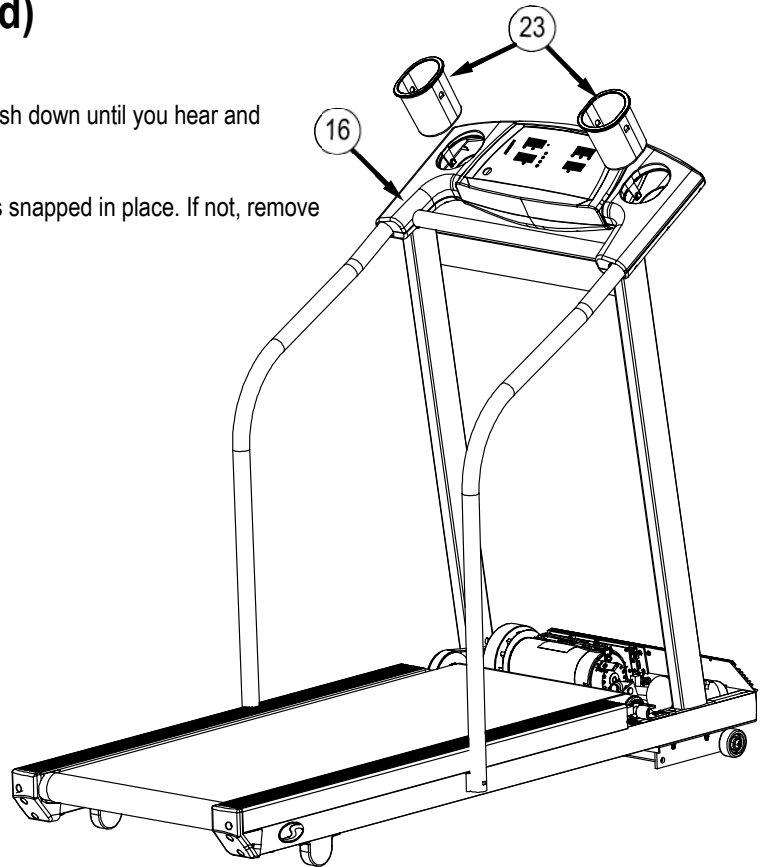

IMPORTANT:

Cup holder comes with a black foam pad to be kept on the bottom of the cup holder. This will help protect your cup holder from being scratched and reduce noise.

DO NOT THROW AWAY.

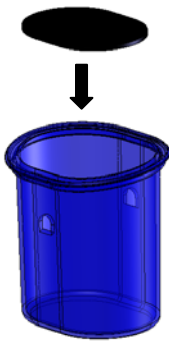

Step Twelve:

To install the motor cover, stand in front of the treadmill. Pick up the motor cover (24) so it is level. Holding the motor cover level and waist high, tilt it 45 degrees by lowering your left hand. Then slide it between the handlebars and lower the motor cover until it is level. Lower the cover all the way, keeping it level. Screw the two #8x1/2" black sheet metal screws (25) into the front of the motor cover. Press down on each side of the motor cover where it meets the silver plastic deck shrouds to lock the Velcro pads into place.

CAUTION: Do not raise or lower motor cover without it being level.

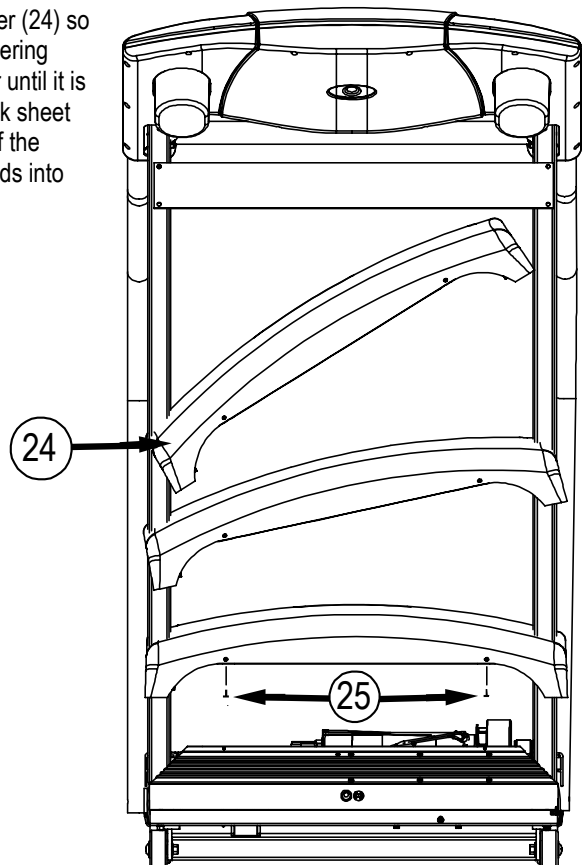

ASSEMBLY INSTRUCTIONS (cont'd)

Step Thirteen:

Assembly is complete, please proceed to testing your treadmill on the next page.

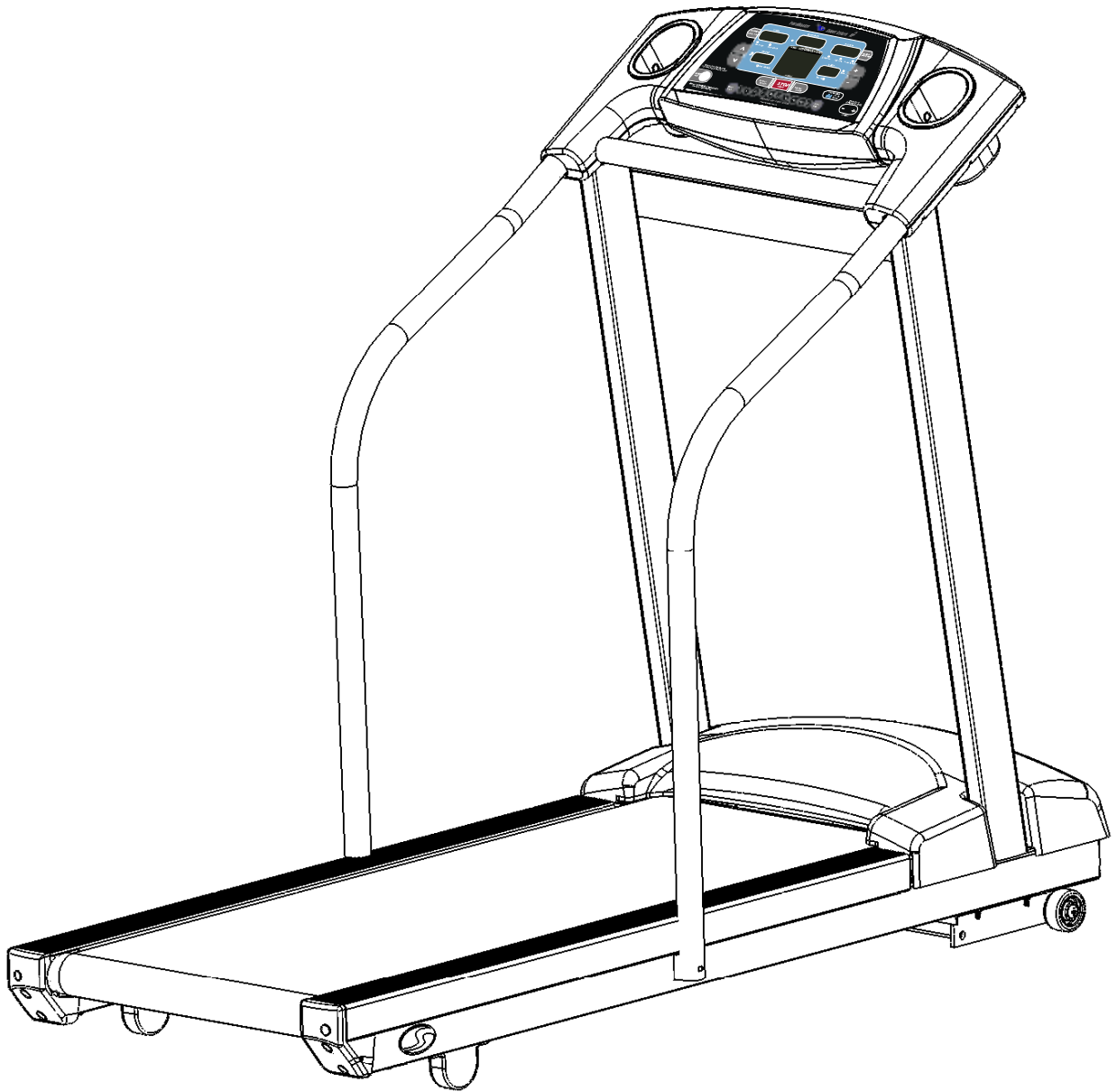

Testing Your Treadmill





Your PaceMaster has been adjusted and tested at the factory. However, due to changes that can occur during shipment, it should be tested prior to use. Once you have assembled your treadmill and it is located where it will be used, proceed as follows. (Do not make any adjustments unless necessary.) **For the purpose of this test, DO NOT stand on the tread belt. Once tested, always start and finish on the tread belt.**

Follow the steps below to confirm proper operation of your treadmill after assembly.

Step One:

After your treadmill is in place and plugged in to the wall outlet, insert the magnetic safety key into the recess on the control panel.

Step Two:

Press the Incline   buttons to set your weight and the Speed   buttons to set your age, then press the  button.

Step Three:

Set the workout speed by pressing the SPEED  button until the SPEED display shows 2.5 mph.



Step Four:

Press the START  button. Within a few seconds, the tread belt will begin to move. The speed display will flash until the tread belt has reached the set speed.

Step Five:

After the treadmill has reached 2.5 mph, observe the tread belt to make sure it is **reasonably** centered. If the tread belt is not **reasonably** centered, press the STOP  button and refer to “Centering the Tread Belt” in the Care and Maintenance section of this manual. Once the tread belt is reasonably centered, run the treadmill at 2.5 mph for 5 minutes to be sure it remains centered.

Step Six:

To test the elevation, the tread belt must be moving. Press the incline up  button to raise the elevation to 5% incline. The elevation will be displayed in the INCLINE display window. Once it reaches 5%, press the incline down  button to reduce the incline to 0%. If the treadmill does not elevate, or displays “Err” in the incline display consult the troubleshooting section of this manual.

Step Seven:

Press STOP  You are now ready to use your treadmill.

THE PACEMASTER SILVER SELECT XP CONTROL PANEL

Although your PaceMaster has many advanced features to provide versatility in meeting exercise needs, basic operation is extremely easy. Basic operation involves setting your TIME and SPEED goals, then pressing the START button. Your PaceMaster will gradually accelerate to the set speed, maintain that speed until the timer counts to zero and then gradually come to a complete stop. During your exercise, your time remaining, current speed, distance traveled, calories burned and Aerobic Points earned are displayed.



MAGNETIC SAFETY KEY - The MAGNETIC SAFETY KEY, with its red cord and garment clip, is an important safety feature. It is also the ON/OFF switch. To power up your treadmill, first attach the garment clip to your clothing at waist level then insert the magnetic key into the round recess on the control panel. This safety key provides a means of powering down the treadmill in an emergency situation. This treadmill will not operate unless the MAGNETIC SAFETY KEY is engaged. During exercise, an emergency stop can be made at any time by pulling on the cord to release the key from its slot.

CAUTION: Using the key to stop the treadmill is an emergency procedure only! To end your exercise routine normally, press the STOP button or allow the timer to count down to zero. Once the belt has come to a complete stop, remove the MAGNETIC SAFETY KEY to turn off the treadmill. When not in use, store the MAGNETIC SAFETY KEY in a safe place to prevent unauthorized use.

BUTTON DEFINITIONS



INCLINE ▲ and ▼ buttons – Have two functions. 1) Use these buttons to adjust the user weight. 2) These buttons increase or decrease incline to simulate exercising up hill. Incline can be changed at any time during your workout. At the end of your workout, the Incline setting will automatically return to 0%.



SPEED + and - buttons – Have two functions. 1) Use these buttons to adjust the user age. 2) Use these buttons to increase or decrease Speed. Adjust your speed at any time during your main workout. The treadmill computer controls the speed during the warm up and cool down phases of your workout.



START (QUICK) button – Press this button to start your workout or to return from a paused state.



STOP (RESET) button – Press this button to end your workout. If pressed when the treadmill is stopped it will reset the display.

THE PACEMASTER SILVER SELECT XP CONTROL PANEL (cont'd)



PAUSE (ENTER) button – Has two functions. 1) It is used to **ENTER** your body weight and the program time for a workout. 2) During a workout, pressing this button will **PAUSE** your exercise, or put it "on hold". The treadmill stops but retains the distance, calories and Aerobic Points accumulated thus far, as well as the speed setting and remaining time. The symbol **-P-** flashes in the SPEED display to indicate the PAUSE feature has been activated. To resume your workout where you left off, press **START**. This feature is will not work during a cool down. This feature can not be used in the cool down mode or heart rate control programs.



Warm Up / Cool Down button – Prior to starting, this button allows you to add or remove a 5-minute Warm Up and/or 5-minute Cool Down phases to your workout. During Warm Up, pressing the Warm Up / Cool Down button discards the remaining warm up time and advances you to the main workout phase. During the main workout, pressing the Warm Up / Cool Down button discards the remaining time and starts the Cool Down phase. Fitness experts strongly recommend a warm up before and a cool down following your aerobic workouts. See the WARM UP and COOL DOWN section in this manual for details.



SELECT (PREVIEW) button – Has two functions. 1) Prior to and during your workout this button is used to select the value (distance, calories, or aerobic points) displayed in the Results window. During your workout you can press and hold this button until the word "SCAn" appears in the Results display, now each value (distance, calories, and points) will be displayed for 3 seconds on a rotating cycle. 2) It is used to change the treadmill setting from English units to Metric units (see "Metric units" page 12).



PROGRAMS buttons – The PROGRAMS button is used to select one of the programmed workouts. For details, refer to the PROGRAMS section in this manual.



PROGRAM INTENSITY LEVEL (TIMER) buttons – Has two functions. 1) Use these buttons to set your workout time for both a TIMED WORKOUT and the factory WORKOUTS. 2) Use these buttons to set or change the program intensity level in a programmed WORKOUT.



EXPRESS KEYS – As an alternative to continually pressing the INCLINE ▲ or

▼ buttons to increase or decrease incline or the SPEED + or - buttons to increase or decrease speed, See the section "Using Express Buttons".



EXPRESS INCLINE –. For example, if you want to adjust the incline to 10%, press the EXPRESS INCLINE button, then 1, then 0. The incline will automatically increase to 10%. The EXPRESS INCLINE buttons adjusts incline in 1.0% increments. To adjust the incline to 8.0%, press EXPRESS INCLINE, then 8.



EXPRESS SPEED – For example, if you choose to increase the speed to 5.0 mph, press the EXPRESS SPEED button, then 5, then 0. The speed will automatically be increased to 5 mph. The EXPRESS SPEED buttons adjust speed in 0.1 mph increments. To adjust speed to 5.3 mph, press EXPRESS SPEED, then 5, then 3.

DISPLAYS

RESULTS display – Displays Distance, Calories and Aerobic Points. Additionally, during the selection or use of a programmed WORKOUT the chosen or current intensity level is displayed.

TIMER display – Displays time in minutes and seconds (mm:ss) up to 59 minutes and 59 seconds. Times of 1 hour to a maximum of 4 hours are displayed as hours and minutes (- h: mm), with the dash as the first digit. For example, - 1:15 represents one hour and 15 minutes. In Quick Start, the TIME display counts up (elapsed time). In other modes of operation the TIME display counts down (time remaining). When using warm up and/or cool down, time will display as a 5-minute countdown for the warm up phase, a countdown for the main exercise phase and then a 5-minute countdown for the cool down phase.

THE PACEMASTER SILVER SELECT XP CONTROL PANEL (cont'd)

SPEED display – Displays Speed from 0.5 mph to 11.0 mph, in 0.1 mph increments. Prior to starting, the displayed value is the Speed the treadmill will seek once START is pressed. Once your workout has begun, the current Speed is displayed. The speed display will flash until the set speed is reached.

INCLINE display – Displays Incline from 0% to 15.0%, in 0.5% increments. Prior to starting, the displayed value is the current incline or the incline the treadmill will seek once START is pressed. Once your workout has begun, the current Incline is displayed.

HEART RATE display – Displays actual heart rate if you are wearing your Polar wireless chest strap. Refer to the Heart Rate section in this manual for more information.

INDICATOR LIGHTS

Set Weight indicator – 3 seconds after the magnetic safety key is inserted, the Set Weight indicator flashes and the last entered body weight is shown on the INCLINE display. Body weight can be adjusted using the INCLINE buttons. Once the desired setting is displayed, press PAUSE (ENTER).

Set Age indicator – 3 seconds after the magnetic safety key is inserted, the Set Age indicator flashes and the last entered age is shown on the SPEED display. Age can be adjusted using the SPEED buttons. Once the desired setting is displayed, press PAUSE (ENTER).

INCLINE Max indicator – When illuminated during the selection of a programmed workout, the displayed Incline is the maximum incline that will be encountered during the selected workout and intensity level.

SPEED Max indicator – When illuminated during selection of a programmed workouts, the displayed speed is the maximum speed that will be encountered during the selected workout and intensity level.

WARM Up and COOL DOWN indicators – Illuminated Warm Up or Cool Down indicators show that these routines will be part of the workout. When in the Warm Up or Cool Down mode, the appropriate indicator will blink.

DISTANCE, CALORIES, And AEROBIC POINTS indicators – They tell you which value is being displayed in the Results window.

OPERATING INSTRUCTIONS

Initially, you may want to keep both hands on the side rails until you feel comfortable walking on your PaceMaster. Once you feel comfortable, try removing your hands to let them swing naturally, as you would when walking outdoors. Always hold on to the side rail or front handle bar with one hand when operating the buttons of the control panel.

THE FIRST STEP





Stand on the center of the treadmill belt. Attach the garment clip on the end of the magnetic safety key to your clothing at waist level. Insert the safety key into the recess on the control panel keyboard.

METRIC UNITS

PaceMaster treadmills can be configured to operate in English (lbs, mph, and miles) or Metric units (kg, kph, and kilometers) of measure. To determine the present configuration of your PaceMaster insert the magnetic key, if "USA" is displayed in the "RESULTS" window it is configured in English, if "Eur" is displayed in the "RESULTS" window, it is configured in Metric. To change between English and Metric insert the magnetic key, as soon as the current setting (USA or EUR) is displayed in the Results window, press and hold the SELECT (PREVIEW) button until the setting changes. Press PAUSE (ENTER) to confirm the selection.

SETTING YOUR WEIGHT AND AGE

Your PaceMaster calculates caloric expenditure based on the formula developed by the American College of Sports Medicine. To ensure accuracy, your weight is required. Your PaceMaster calculates heart rate information based on the age you enter prior to your workout.

To ensure safety and accuracy, your age is required. Once the magnetic key has been inserted, Press the Incline   buttons to set your weight and the Speed   buttons to set your age, then press the  button.

WARM UP AND COOL DOWN

By warming up prior to beginning the aerobic phase of your workout, you accomplish 2 goals; you stretch and warm up the muscles of the back and extremities and create a slight acceleration of the heart rate so that the body can move gradually into the higher heart rate of the aerobic phase. The aerobic phase should be followed by a minimum 5-minute cool down in which you keep moving at a slower pace. This allows your heart rate to gradually decline and your body to gently adjust to the end of a workout instead of abruptly stopping. The cool down phase also allows blood to be pumped from the lower extremities back to the central circulatory system. Simply put, the function of warming up and cooling down is to ease you from a resting state into an active state and back to a resting state.

The treadmill's computer, based on your main exercise starting and finishing speeds respectively, automatically calculates warm up and cool down speeds.

When in the warm up mode, the TIME display window counts down from 5 minutes and the Warm Up indicator light will blink. When in the Cool Down mode, the TIME display window counts down from 5 minutes and the Cool Down indicator light will blink.

To add warm up and/or cool down to a TIMED workout press the Warm Up / Cool Down button. The indicator light will blink, indicating that the desired mode has been added to your workout. You will also notice that the workout time increases by 5 minutes for each addition.

To shorten the warm up mode, press the Warm Up / Cool Down button once. Warm up will be ended and you will advance into the main exercise. To shorten the main exercise, press the Warm Up / Cool Down button and you will automatically begin the cool down phase. To end the cool down, press STOP and your session will come to a close.

A cool down phase can be added to any workout (even if it wasn't chosen prior to beginning the workout) by pressing the Warm Up / Cool Down button.

Now you are ready to choose your workout mode. Whether it is Quick Start, Timed Workout (Manual), or one of the Variable Intensity Programs, the following pages give you step-by-step instructions on how to use each workout.

QUICK START





Quick Start allows you to begin your workout by pressing one button. You control the speed, incline and time.

Step One:

Stand on the running belt and attach the garment clip on the end of the magnetic safety key to your clothing. Insert the safety key into its recess on the control panel.

Step Two:

Press the  button. Within a few seconds, the tread belt will begin to move. The speed display will flash until the tread belt has reached the set speed.

- Adjust the speed at any time during your workout by pressing the SPEED   buttons. Speed will adjust in 0.1 mph increments
- Add incline at any time during your workout by pressing the INCLINE   buttons. Elevation will adjust in 0.5% increments.
- Add a 5 minute Cool Down to the end of your workout by pressing the  button when you are ready.

TIP: You can pause your workout by pressing the PAUSE  button. This feature is not available in cool down or heart rate control. To resume, press the START  button.

TIP: During your workout you can press and hold the SELECT  button until the word “SCAN” appears, each value (distance, calories, and points) will now be displayed for 3 seconds on a rotating cycle.

Step Three:

To end your workout, press the STOP  button. The treadmill will display the total time distance, calories, and Aerobic Points.

If a problem should occur, your PaceMaster can be stopped quickly by pulling on the magnetic safety cord to dislodge the key from the control panel. The treadmill will stop a bit more abruptly, but still gently enough to prevent you from being injured. **This is an emergency procedure only and should not be used as the normal stopping procedure.**





TIMED WORKOUT (MANUAL)

Timed Workout allows you to choose the length of time and the degree of intensity for your workout. You can make speed and incline adjustments at any time during the workout.

Step One:

Stand on the running belt and attach the garment clip on the end of the magnetic safety key to your clothing. Insert the safety key into its recess on the control panel.



Step Two:



Press the Incline   buttons to set your weight and the Speed   buttons to set your age, then press the  button.

Step Three:

Enter the starting speed by press the SPEED  button until the desired speed appears in the SPEED display window. Speed can be adjusted at any time during your workout.

Step Four:

Enter the workout time by pressing the PROGRAM INTENSITY LEVEL (TIMER)   buttons until the desired workout time appears. If you hold either of the buttons down the time scrolls quickly.

- If you wish to include warm up and/or cool down to your workout, press the  button until the indicator light next to the desired mode is illuminated. You will notice that your workout time will automatically increase by 5 minutes for each addition. For details, refer to the WARM UP AND COOL DOWN section in this manual.
- Adjust incline by pressing the INCLINE   buttons. Elevation is adjusted in 0.5% increments.



NOTE: During setup your predicted distance, calories, and Aerobic points will be displayed in the RESULTS window.

Step Five:

Press START  and your PaceMaster will gradually accelerate until it reaches the entered speed.

Step Six:

To end your workout, either allow the timer to count down to zero or press the STOP  button. The treadmill will display the total time, distance, calories, and Aerobic Points.

TIP: You can pause your workout by pressing the PAUSE  button. This feature is not available in cool down or heart rate control. To resume, press the START  button.

TIP: During your workout you can press and hold the SELECT  button until the word "SCAN" appears in the RESULTS display, each value (distance, calories, and points) will now be displayed for 3 seconds on a rotating cycle.

If a problem should occur, your PaceMaster can be stopped quickly by pulling on the magnetic safety cord to dislodge the key from the control panel. The treadmill will stop a bit more abruptly, but still gently enough to prevent you from being injured. **This is an emergency procedure only and should not be used as the normal stopping procedure.**

PROGRAMS

To assist you in reaching your fitness goals, your PaceMaster comes with a variety of programmed workouts. You will be alerted to any speed and/or elevation changes in the workouts with 5 audible chirps and a flashing speed and/or incline display.

P1 CALORIE COACH





The Calorie Coach program enables you to select the number of calories you want to burn. Then, based on the speed and incline you enter, the treadmill's computer will determine the time required to achieve your calorie expenditure goal.

USING P1 CALORIE COACH:

Step One:

Stand on the running belt and attach the garment clip on the end of the magnetic safety key to your clothing. Insert the safety key into its recess on the control panel.

Step Two:

Press the Incline   buttons to set your weight and the Speed   buttons to set your age, then press the  button.

Step Three:

Press the  button once and P1 will appear in the RESULTS window. A mug will appear in the Profile display window and number (example: C100) will appear in the RESULTS display window. C100 represents 100 calories. This number will vary with user selected variables.

NOTE: Warm up and Cool down are integral part of this program, therefore they can not be removed.

Step Four:

Use the  buttons set the number of calories you want to burn; this is displayed in the RESULTS window.

Step Five:

To set the starting speed and incline, press the Speed   buttons and the Incline   buttons until the desired settings appear in the corresponding display windows. The treadmill will automatically calculate the amount of exercise time necessary to achieve the selected caloric expenditure.

Step Six:

Press , you will be in the warm-up phase, you will see the warm-up steps in the PROFILE display window. Following the warm up phase, you will see the OneLap™ Track in the PROFILE display window. The RESULTS window will show a count up of the calories burned thus far.

TIP: You can pause your workout by pressing the  button. This feature is not available in cool down or heart rate control. To resume, press the  button.





PROGRAMS (cont'd)

USING P2, P3, P4, P5, and P7: Each of these programs offers 9 levels of intensity. Additionally, workout time can be set from 20 to 60 minutes in 5 minute increments.

Step One:

Stand on the running belt and attach the garment clip on the end of the magnetic safety key to your clothing. Insert the safety key into its recess on the control panel.

Step Two:



Press the Incline   buttons to set your weight and the Speed   buttons to set your age, then press the  button.

Step Three:

Press the  button to select the desired program, P2, P3, P4, P5 or P7.

Step Four:

The default workout time of 30:00 minutes will be flashing in the TIMER display. Use the PROGRAM INTENSITY LEVEL (TIMER)

  buttons to adjust your total workout time, then press the  button. Total workout time can be set from 20 to 60 minutes, this includes a warm up & cool down.

TIP: Warm up and cool down periods are automatically added to all the programmed Workouts. If you wish to remove the warm up and/or

cool down phases, press the  until the corresponding indicator light is no longer illuminated.

Step Five:

Press the PROGRAM INTENSITY LEVEL (TIMER)  button to adjust the level of intensity. The level will be displayed in the RESULTS display window preceded with the letter "L". The maximum incline for that level will be displayed in the INCLINE display and the maximum speed for that level will be displayed in the SPEED display and the MAX indicator lights will also be illuminated. You can adjust

the level of intensity at any time during your workout by pressing the  buttons.

Step Six:

Press the  button and your PaceMaster will gradually accelerate. Your workout will end when the timer has counted down to zero or the STOP button is pressed. Total time, distance, calories, and Aerobic Points will be displayed.

TIP: You can pause your workout by pressing the  button. This feature is not available in cool down or heart rate control. To resume, press the  button.

If a problem should occur, your PaceMaster can be stopped quickly by pulling on the magnetic safety cord to dislodge the key from the Control Panel. The treadmill will stop a bit more abruptly, but still gently enough to prevent you from being injured. **This is an emergency procedure only and should not be used as the normal stopping procedure.**





PROGRAMS (cont'd)

USING P6: This workout is a 5 kilometer run, the user sets speed and incline and the computer calculates the workout time.

Step One:

Stand on the running belt and attach the garment clip on the end of the magnetic safety key to your clothing. Insert the safety key into its recess on the control panel.





Step Two:

Press the Incline   buttons to set your weight and the Speed   buttons to set your age, then press the  button to store your personal information.

Step Three:

Press the  button until P6 is displayed in the RESULTS window.

Step Four:

Set your speed using the   buttons, set your incline using the   buttons.

Step Five:

Press the START  button and your PaceMaster will gradually accelerate. Your workout will end when the timer has counted down to zero or the STOP button is pressed. Total time, calories, Aerobic Points and distance will be displayed.

NOTE: Adjustments made to the speed during your workout will automatically update the remaining workout time.

USING P8 and P9:





To be certain you are receiving the maximum benefit from your workout, wear your wireless chest strap transmitter and activate the HeartSmart™ Pulse Monitoring System. The heart rate training zone in which you are currently exercising will be displayed on the Heart Rate Zone bar in the PROFILE display window.

To begin using P8 & P9 *Body for Life* recommended factory set programs: Each of the custom workouts have been preprogrammed at the factory with the best selling book, *Body For Life*, recommended cardio interval workouts. There are two levels of difficulty, C1 being the easiest and C2 being more intense. These workouts can be overridden to create your own custom programs



Step One:

Stand on the running belt and attach the garment clip on the end of the magnetic safety key to your clothing. Insert the safety key into its recess on the control panel.

Step Two:

Press the Incline   buttons to set your weight and the Speed   buttons to set your age, then press the  button.

Step Three:

Press the  button to select the desired program, P8 or P9. Press the  button to add a warm up and/or cool down.

PROGRAMS (cont'd)

Step Four:



Press the  button to begin your program.

TIP: You can pause your workout by pressing the  button. This feature is not available in warm up or heart rate control.

To resume, press the  button.

To restore a *Body for Life* recommended cardio workout after it has been Recorded over:

Step One:





Press the  button to select the program position you want to recover, P8 or P9. Press and hold the  button until **rst** (restore) appears in the RESULTS window.

To RECORD a CUSTOM program in P8 or P9:

Step One:



Stand on the running belt and attach the garment clip on the end of the magnetic safety key to your clothing. Insert the safety key into its recess on the control panel.

Step Two:

Press the Incline   buttons to set your weight and the Speed   buttons to set your age, then press the  button.

TIP: To monitor your heart rate, put on the chest strap transmitter and press the HEART RATE button. **H1** will appear in the RESULTS display window. This activates the HeartSmart™ monitoring system.

Step Three:

Press  button to select the desired program position to record your workout, P8 or P9. Press the  button. **Rec** will appear in the PROFILE display window.





Step Four:

To set the starting speed and incline, press the Speed   buttons and the Incline   buttons until the desired settings appear in the corresponding display windows.

Step Five:

Press the  button to begin your workout.

Step Six:

You can make a maximum of 50 changes for each workout by pressing the Speed   buttons and the Incline   buttons. Each time a change is made, **REC** will appear in the RESULTS window indicating that the treadmill's computer is recording the change. As soon as the change has been recorded, **REC** will disappear and another change can be made. Speed and incline changes

PROGRAMS (cont'd)

can be also be made by using the  buttons. For details, refer to Express buttons in this manual.

Your workout will end when the  button has been pressed. **Stop** will appear in the RESULTS display window, indicating that you have successfully recorded your custom program. **Do not end your workout by removing the safety magnetic or your program will not be recorded.**

Note: The current distance will be displayed the RESULTS display window. To lock onto distance, calories, or Aerobic Points, press the

 button. An LED light will be illuminated next to the data currently appearing in the RESULTS display window. To scan your

workout results while exercising, press and hold the  button until the word **SCAN** appears in the RESULTS display window. Each value will be displayed for 3 seconds.

NOTE: You will see a graphic depiction of the Time Spent in Zone in the PROFILE display window, if you were wearing the wireless chest strap during your workout.

If a problem should occur, the treadmill can be stopped quickly by pulling on the magnetic safety cord to dislodge the key from the Control Panel. The treadmill will stop a bit more abruptly, but still gently enough to prevent you from being injured. **This is an emergency procedure only and should not be used as the normal stopping procedure.**

Program Specifications – P2, P3, & P4

P2				
Level	Speed		Incline	
	Min	Max	Min	Max
1	2.4	2.4	1.0	5.0
2	2.8	2.8	2.0	6.0
3	3.2	3.2	3.0	7.0
4	3.6	3.6	4.0	8.0
5	4.0	4.0	5.0	9.0
6	4.4	4.4	6.0	10.0
7	4.8	4.8	7.0	11.0
8	5.2	5.2	8.0	12.0
9	5.6	5.6	9.0	13.0

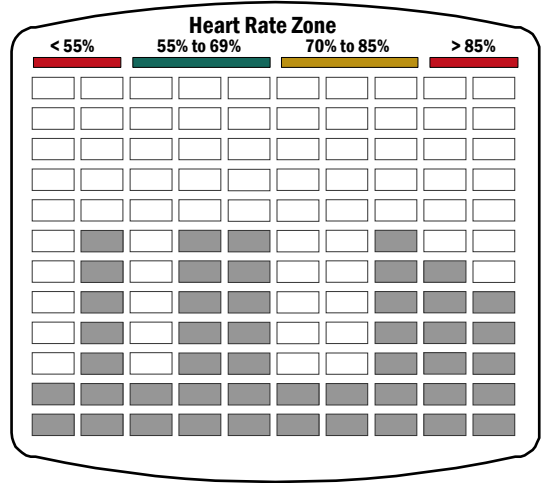

P3				
Level	Speed		Incline	
	Min	Max	Min	Max
1	1.6	2.8	0.0	6.0
2	2.2	3.4	0.0	6.0
3	2.8	4.0	0.0	6.0
4	3.4	4.6	0.0	6.0
5	4.0	5.2	0.0	6.0
6	4.6	5.8	0.0	6.0
7	5.2	6.4	0.0	6.0
8	5.8	7.0	0.0	6.0
9	6.4	7.6	0.0	6.0

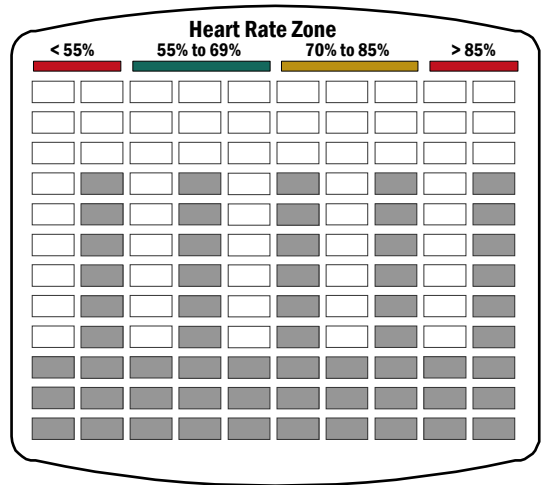

P4				
Level	Speed		Incline	
	Min	Max	Min	Max
1	1.4	2.8	0.0	0.0
2	2.0	3.4	0.0	0.0
3	2.6	4.0	0.0	0.0
4	3.2	4.6	0.0	0.0
5	3.8	5.2	0.0	0.0
6	4.4	5.8	0.0	0.0
7	5.0	6.4	0.0	0.0
8	5.6	7.0	0.0	0.0
9	6.2	7.6	0.0	0.0

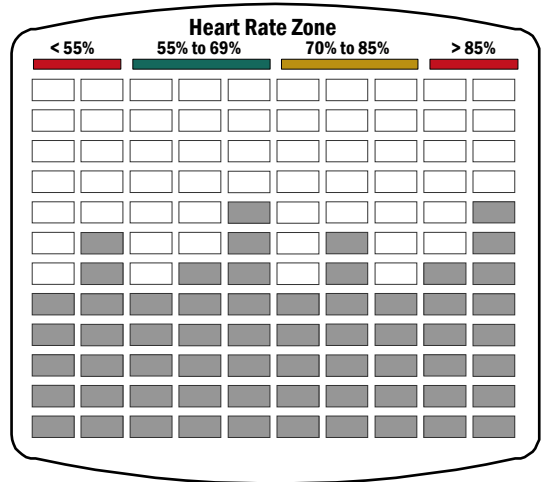

Program Specifications – P5 & P7

P5				
Level	Speed		Incline	
	Min	Max	Min	Max
1	1.4	2.0	0.0	6.0
2	1.8	2.4	0.5	6.5
3	2.2	2.8	1.0	7.0
4	2.6	3.2	1.5	7.5
5	3.0	3.6	2.0	8.0
6	3.4	4.0	2.5	8.5
7	3.8	4.4	3.0	9.0
8	4.2	4.8	3.5	9.5
9	4.6	5.2	4.0	10.0

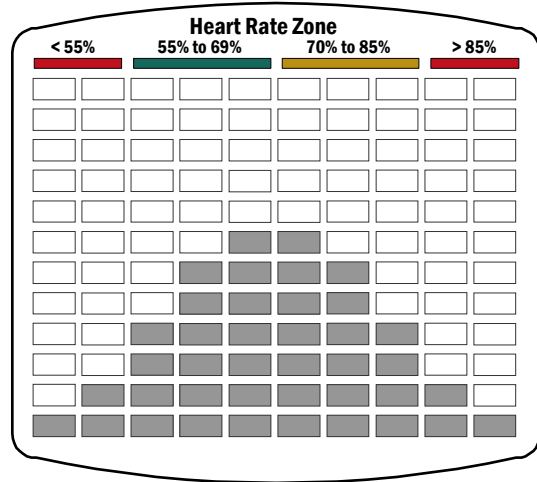

P7				
Level	Speed		Incline	
	Min	Max	Min	Max
1	1.4	2.6	0.0	6.0
2	2.0	3.2	0.0	6.0
3	2.6	3.8	0.0	6.0
4	3.2	4.4	0.0	6.0
5	3.8	5.0	0.0	6.0
6	4.4	5.6	0.0	6.0
7	5.0	6.2	0.0	6.0
8	5.6	6.8	0.0	6.0
9	6.2	7.4	0.0	6.0

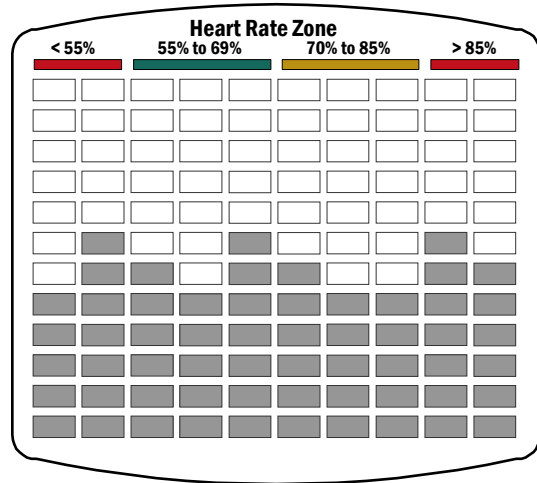

HEART RATE PROGRAMS H1, H2, and H3

TRAIN LESS AND BENEFIT MORE FROM YOUR WORKOUTS

To maximize the benefits from your workouts, you must maintain a sufficiently high heart rate. Target heart rate training takes the guesswork out of exercising. It provides you with the means to train within safe and effective ranges, all the while maximizing your exercise time and effort.

The PaceMaster Silver Select XP has integrated heart rate control programs, which act as your personal trainer. You set your target based on your individual fitness goal (weight management or cardiovascular improvement), the time and maximum speed and incline parameters and the treadmill does the rest.

TIP: Based on the age entered, your PaceMaster treadmill automatically calculates your theoretical maximum heart rate and the Heart Rate Zone bar indicates which portion of your heart rate training zone (fat burn or aerobic) you are currently training. The fat burn zone is between 55% and 69% of your theoretical maximum heart rate. The aerobic zone is between 70% and 85% of your theoretical maximum heart rate.

The PaceMaster Silver Select uses the Runners World standard formula to calculate your theoretical maximum heart rate. The formula is 205 minus $\frac{1}{2}$ your age. For example, if you are 40 years old, your theoretical maximum is 185 beats per minute (bpm). When your heart rate is between 102 and 128 bpm, you are training in the fat burn zone for weight management. When your heart rate is between 130 to 157 bpm, you are training in the aerobic training zone for cardiovascular improvement. The safest and most recommended method of determining your maximum heart rate is to have a physician administer a stress test.

THE WIRELESS CHEST STRAP TRANSMITTER

The PaceMaster Silver Select XP treadmill comes equipped with a **WIRELESS CHEST STRAP TRANSMITTER**, which, when worn, measures pulse (number of heart beats per minute) and relays the information by way of RF to a receiver built into the treadmill's computer.

This chest strap must be worn to activate the Heart Rate Monitoring. The Heart Rate Control workouts are non-operational unless the chest strap is worn.

PUTTING ON THE CHEST STRAP

To properly wear your chest strap, adjust the strap to fit snugly and comfortably around your chest with the electrodes (the grooved areas) directly over your sternum, as pictured to the right. For best results, the strap should be worn against skin. Moisture is necessary for the transmitter to function properly. Usually, perspiration is sufficient, but you may need to moisten the electrodes with water.

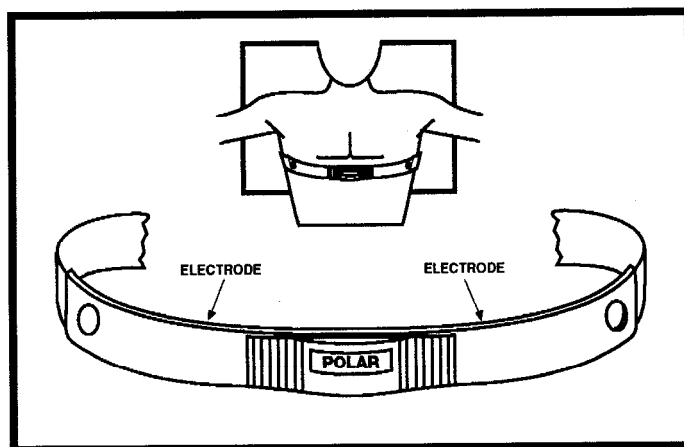

MONITORING YOUR HEART RATE

If you wear the wireless chest strap as described above, your heart rate will be displayed in the heart rate window during all modes of operation.

HEART RATE PROGRAMS

Your PaceMaster Silver Select XP treadmill offers the following Heart Rate Control programs:

H1 - Target HRC: Choose a heart rate training zone between 55% and 85% of your theoretical maximum.

H2 - Fat Burn HRC: Choose one of five levels in the fat burn training zone, between 55% and 69% of your theoretical maximum.

H3 - Cardio HRC: Choose one of five levels in the aerobic training zone, between 70% and 85% of your theoretical maximum.

NOTE: The PAUSE feature will not operate in ANY heart rate control program to avoid any undue cardiovascular stress.

HEART RATE PROGRAMS (cont'd)

To begin using TARGET HRC, FAT BURN HRC, and CARDIO HRC:





Step One:

Put on the chest strap transmitter as pictured on page 23.

Step Two:

Stand on the running belt and attach the garment clip on the end of the magnetic safety key to your clothing. Insert the safety key into its recess on the control panel.

Step Three:

Press the Incline   buttons to set your weight and the Speed   buttons to set your age, then press the  button.

Step Four:

Press the  button to select the desired HEART RATE workout, H1 through H3 (H1-H3 will appear in the results window).

Step Five:

Set the desired workout time using the  buttons. Workout time can be set from 20 to 60 minutes in 5 minute increments

Step Six:

Press the  button.

NOTE: The treadmill must be receiving a heart rate signal to proceed. If no heart rate signal is being received, all displays go blank with the exception of the graphic display of the heart, and four dashes in the results window. Review "Putting on the chest strap" instructions on page 23.

Step Seven:

The default max incline is 10.0% and the default max speed is 4.0 mph will appear in their corresponding windows and a target heart rate will appear in the RESULTS display window. Set the desired maximum speed using the SPEED buttons and the desired maximum incline by pressing the INCLINE buttons. **These parameters should be no faster or incline no higher than you feel comfortable reaching.** As a safety feature, your PaceMaster treadmill will **NEVER** exceed the speed and incline parameters you have set, even if they are not sufficient to get you to your target heart rate. **NOTE:** The treadmill will take you to your target based on your heart rate, not necessarily the speed and incline you entered. You will not reach the entered maximum speed and incline if your heart rate reaches the target at a lower speed and/or incline. Speed and incline target changes can be made at any time during your workout.

Step Eight:

Set the desired target Heart Rate by pressing the  buttons.

- In H1 (Target HRC), you can choose a target heart rate from 55% to 85% of your theoretical maximum.
- In H2 (Fat Burn HRC), you can choose one of the 3 target heart rate zones optimal for weight management; from 55% to 69% of your theoretical maximum.
- In H3 (Cardio HRC), you can choose one of the 3 target heart rate zones optimal for aerobic training, from 70% to 85% of your theoretical maximum.

HEART RATE PROGRAMS (cont'd)

Step Nine:

Press the  button. After the warm up phase, you will see a graphic depiction of a heart and a ⊥ (the On-Target Indicator) in the PROFILE display window. When your heart rate is at the target the ⊥ (On-Target Indicator) will be centered under the heart depicted in the Profile display. Correspondingly, when the heart rate falls below target the ⊥ (On-Target Indicator) will move to the left of center and if the heart rate exceeds the target the ⊥ (On-Target Indicator) will move to the right of center.

TIP: Because the warm up and cool down phases are an essential part of your workout, they cannot be deleted prior to beginning a Heart Rate workout. You will automatically advance into your main workout as soon as your heart rate reaches the target or at the end of the 5-minute warm up, whichever occurs first. If you choose to bypass the warm up phase, after you press the START button, you can proceed

into the main workout by pressing the  button once.

Your workout will end when the timer has counted down to zero or the STOP button has been pressed. The treadmill will display total time, current heart rate, calories expended, Aerobic Points earned, elapsed distance and average speed. The PROFILE display window will show a graphic review of your workout.

If a problem should occur, the treadmill can be stopped quickly by pulling on the magnetic safety cord to dislodge the key from the control panel. The treadmill will stop a bit more abruptly, but still gently enough to prevent you from being injured. **This is an emergency procedure only and should not be used as the normal stopping procedure.**

EXCLUSIVE PACEMASTER FEATURES

Exercise Preview

You can see exactly what you will accomplish prior to beginning a Timed Workout (Manual), or Variable Intensity Workout. An EXERCISE PREVIEW predicts the total distance, caloric expenditure and Aerobic Points to be earned based on the time, incline and speed you chose. After you have selected a Variable Intensity Workout, or have set the speed, time and incline parameters for a Timed Workout (Manual), the predicted calories, Aerobic points, and distance will be displayed in the RESULTS window. Press the SELECT button to change the displayed result. Note that any adjustments to speed, time and incline will change those figures.

Aerobic Points

One of the main reasons people stop exercising is because they don't see the physical changes they expected. Results, however, can only be realized when you are training properly. For this reason, the Aerobic Point System has been incorporated into the design of PaceMaster treadmills since 1968.

The Aerobic Point System was developed by Dr. Kenneth Cooper, the Father of Aerobics and renowned founder of The Cooper Aerobics Institute in Dallas, TX, to measure the aerobic benefit of the workout. Dr. Cooper's formula compares the energy costs of aerobic activity from the mathematical relationships between the oxygen expenditures assigned to each exercise at a given intensity and duration. This formula is built into the PaceMaster computer to automatically calculate the number of AEROBIC POINTS you earn for each workout

Dr. Cooper states in his book, *The Aerobics Program For Total Well Being*, "The main idea of this system is that, in order to stay in good shape and move toward a goal of total well-being, a person must earn a certain number of points each week by doing a certain amount of aerobic exercise." His research has determined that a man should **work up to** a minimum of 32 points per week and a woman should **work up to** a minimum of 27 points per week. The number of weekly points you earn correlates with your level of fitness. The fitness categories are:

Classification	Average Points per Week	
	Men	Women
Very Poor	Less than 10	Less than 8
Poor	10-20	8-15
Fair	21-31	16-26
Good	32-50	27-40
Excellent	51-74	41-64
Superior	75+	65+

If you have not been on a regular exercise program, it is highly recommended that you gradually work up to your desired fitness category and then develop a maintenance program.

You can see the number of AEROBIC POINTS you will earn prior to beginning your workout by pressing the SELECT button until Aerobic Points indicator is illuminated. To design a workout based on the number of AEROBIC POINTS you want to earn, follow the instructions below for PERSONAL ELECTRONIC TRAINER.

Personal Electronic Trainer

Another feature exclusive to PaceMaster treadmills is the PERSONAL ELECTRONIC TRAINER. You can create a workout based on the number of Aerobic Points you want to earn or the number of calories you want to burn.

To create a workout based on Aerobic Points:

Step One:





Determine how many times a week you will be exercising and how many weekly points you want to earn. For example, if you plan on exercising 4 times a week and your goal is to earn 32 points that week, you will need to earn 8 points per workout.

Step Two:

Insert the safety key into its recess on the control panel.

EXCLUSIVE PACEMASTER FEATURES (cont'd)

Step Three:

Press the Incline   buttons to set your weight and the Speed   buttons to set your age, then press the  button.

Step Four:

Enter the workout time by pressing the PROGRAM INTENSITY LEVEL (TIMER)  buttons until the desired workout time appears, you may also add a warm up and/or cool down.

Step Five:

Press the **SELECT (Preview)**  button until the Aerobic Points indicator is illuminated.

Step Six:

Enter speed. You will begin to see the number of Aerobic points you will earn in the RESULTS display as you increase the speed.

Step Seven:

Enter Incline. You will begin to see the number of Aerobic points you will earn in the RESULTS display as you increase the speed. To create a workout based on calorie expenditure, determine how many calories you want to burn Press the **SELECT (Preview)** button until the Calories indicator is illuminated and follow steps 4, 5 and 6 above.

Care and Maintenance

The following section describes necessary maintenance for your PaceMaster treadmill. This maintenance is the responsibility of the purchaser and is not covered under our warranty. Failure to perform this necessary maintenance could result in damage to your treadmill.

⚠ CAUTION: Unplug your treadmill before attempting any cleaning or maintenance.

Deck and Tread Belt Cleaning

The running belt on your PaceMaster rides on a low friction deck. Proper operation will be jeopardized if any water, dirt, solvents, fluids or abrasive materials come between the tread belt and the deck. For this reason, extra care must be used in keeping the belt clean. Use a soft, damp cloth to remove dust, dirt and other substances from the area between the belt and the side of the machine. Do not clean the tread belt by turning on the treadmill.

Lubrication

The motor and roller bearings are sealed for maintenance free operation and require no lubrication. The deck and tread belt are lubricated at the factory.

The side rails are made of steel. By occasionally applying a coat of automotive wax to them will help prevent rusting.

Centering the Tread Belt

To improve belt life, the belt should be **reasonably** centered. To center the belt, walk on the treadmill at 2.5 mph for a few minutes. Determine whether the belt drifts too far to the left or right side. If adjustments are required, stop the treadmill and follow the steps listed below. Never make adjustments while the tread belt is moving.

TIP: If the tread belt is reasonably centered (no closer than 1/8" to the left or right deck shroud) no adjustments are necessary. Unnecessary adjustments can result in premature belt wear.

⚠ CAUTION: Unplug your treadmill before attempting any cleaning or maintenance.

Step One: (figure 6)

If the belt is drifting to the left, using a 3/16" Allen wrench, turn the left-hand adjustment bolt (3) a quarter turn clockwise and the right-hand adjustment bolt (4) a quarter turn counter-clockwise.

If the belt is drifting to the right, using a 3/16" Allen wrench, turn the right-hand adjustment bolt (4) a quarter turn clockwise and the left-hand adjustment bolt (3) a quarter turn counter-clockwise.

Step Two:

Walk on the belt for 1 minute, observing belt tracking. If the belt moves to one side, repeat step 1.

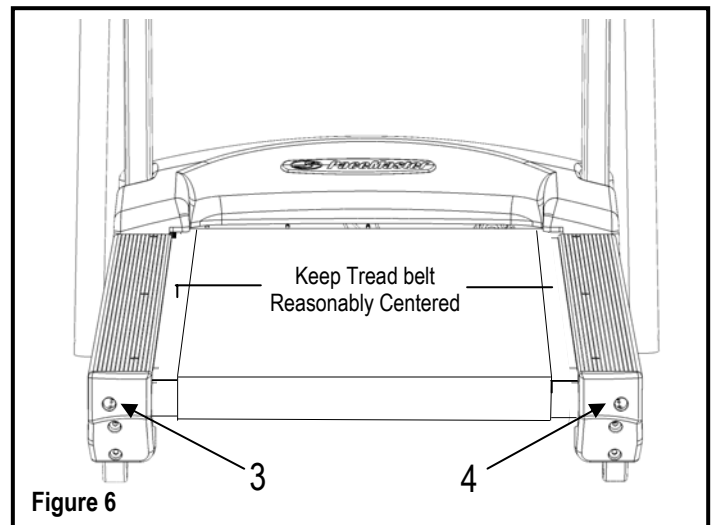

Care and Maintenance (cont'd)

CUP HOLDER

Installation:

Simply place cup holder with the black foam pad into the hole in the control panel. Press down until you hear the cup firmly snap into place.

Note: The cup holder should sit flush to the control panel when it is snapped in place. If not, remove cup holder and rotate 180 degrees, then reinstall.

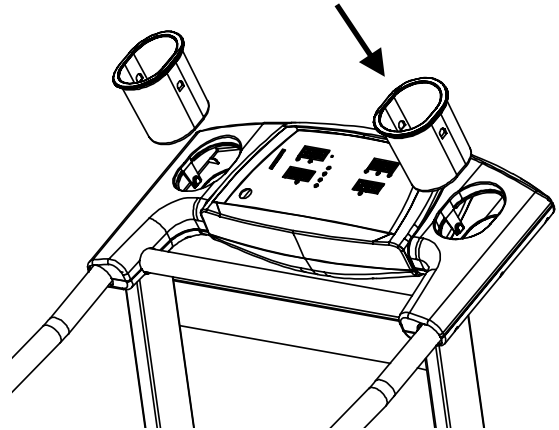

Removal:

Simply tap the bottom of the cup holder with the palm of your hand until it is released from the snaps. Pull up until it completely clears the control panel.

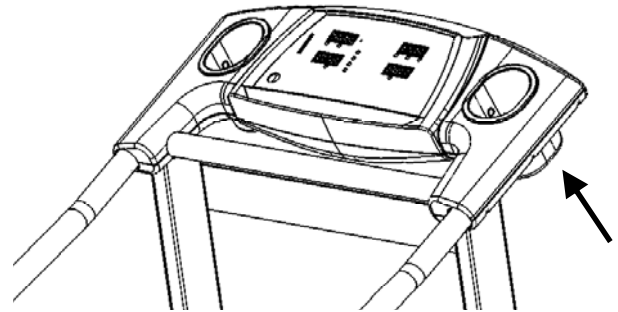

Cleaning:

To safely clean your cup holder, simply hand wash with dish soap or placed in a dishwasher (TOP RACK ONLY). The black foam pad can be rinsed off and lightly scrubbed. **Do not put the black foam pad into the dishwasher.**

TROUBLESHOOTING

⚠ CAUTION: Unplug your treadmill before attempting any cleaning, maintenance, or service.

<h2>Display Does Not Turn On (No Power)</h2>	Is the magnetic key inserted into the control panel?
	Is treadmill plugged into the wall outlet?
	Check the household circuit breaker to see if it is tripped. The treadmill may not operate if plugged into a GFCI (Ground Fault Current Interrupt) outlet.
	Check the treadmill circuit breaker (See Figure 8, page 31). If the circuit breaker is tripped, push reset button back in to reset.
	Make sure the wiring harness is plugged into the power supply (See Figure 2, page 6).
Check both the black power cord and the black wiring harness for damage.	

Electronic Error Codes

Your self-diagnostic PaceMaster treadmill has built in sensors that will determine the precise reason for a problem. If the onboard computer detects a problem, an error code will be displayed. If an error code appears during operation of your treadmill, do the following:

- Make a note of the error code number (see below for example).
- Obtain your serial number, located on the front of the treadmill approximately 10-12 inches to the left of the power cord.
- Write down which mode of operation you were using, the speed and incline that were set and if you were pressing any buttons at the time.
- Contact the PaceMaster dealer where you purchased your treadmill. If you have moved or need the name of the local dealer, visit our website at www.pacemaster.com and choose the dealer locator to find this information.

Example Error Code

If the onboard computer detects a problem, an error code will be displayed. (Example - Err 149)
 “Err” will display in the Time Window, “149” will display in Results Window (see example below).



TROUBLESHOOTING (cont'd)

⚠ CAUTION: Unplug your treadmill before attempting any cleaning, maintenance, or service.

Error Code 133 or 134

This is a communication error that could be a result of the black wire harness not being plugged in all the way. Unplug the treadmill from the wall outlet and reconnect the black wire harness that you plugged in during Step Two of assembly, see page 6.

Error Code 149

Error code 149 indicates a button was pressed when the magnetic key was inserted into the control panel. Do not press down on any button when inserting the magnetic key. Make sure any accessories that are mounted to the control panel (book rack, etc.) are not making contact with the membrane.

Error Code 298

Error Code 298 is an RPM signal code - indicates a loss of the RPM signal during a workout. Check all wiring connections (optical sensor and wiring harness) and all wiring for cuts or damage. (See Figure 2 page 6).

Error Code 307

Indicates that there was no speed sensor signal at start up. Check the speed sensor connection and wiring.

Error Code 425

After start is pressed, the tread belt does not move and then "Err 425" appears. To reset this error code you must unplug the treadmill from the wall outlet for 10 seconds, and then check the items listed below.

Check the drive motor wire connection to the power supply.

Check the ceramic fuse (20 Amp – 250 V) on the power supply.

Elevation Error Codes



"Err" in the Incline Display - indicates a problem with the elevation system. Note: The treadmill will still function with the "Err" displayed in the incline Display, but the elevation system will not function. To determine the exact error code follow the procedure below.

Insert the magnetic key, **For the purpose of this test, DO NOT stand on the tread belt**

If "Err" appears in the incline display after pressing the Start/Quick, Stop/Reset, or Pause/Enter button, the control panel is not receiving an elevation reading. Start the treadmill, then press the Up or Down Incline button, an "E 219" will appear in the Results Display. Check the both wiring connections between the elevation motor and the power supply. Also, check the wiring harness for cuts or visual damage.

If "Err" appears in the incline display after attempting an elevation change, the control panel did not see elevation movement. Touch the incline Up or Down button and an "E 217" will appear in the Data Window. Check the wiring connection between the elevation motor and the power supply. Check the elevation fuse to see if it has blown. If the fuse has blown, replace fuse.

TROUBLESHOOTING (cont'd)

Noises

A Clicking, Rubbing or Grinding noise is present while the tread belt is moving.

Remove all items from the cup holders on either side of the display

Visually confirm that NO foreign objects (children's toys, pet's toys, etc...) are underneath, on top of, or against the treadmill.

With the tread belt stopped visually check to see if the tread belt is reasonable centered, if it is not please refer to "centering the tread belt" under the maintenance section of this manual.

Hesitation of the Tread belt

Hesitation of the tread belt usually indicates slippage of either the tread belt (the belt you walk on) or the drive belt (the belt connecting the drive roller to the motor). To determine which of these belts is slipping, first adjust the drive belt tension and test to see if the slippage stops. If the hesitation is not corrected than the tread belt tension needs adjustment.

 **CAUTION:** Unplug your treadmill before attempting any cleaning or maintenance.

Drive Belt Tension Adjustment

Step One:

Use a Phillips head screwdriver to remove the 2 screws that hold the front of the motor cover in place and remove the motor cover.

Step Two: (figure 7)

Locate the four motor mount screws (item 1 in fig 7) as shown in the diagram and loosen them each two turns each using the 3/16" allen wrench.

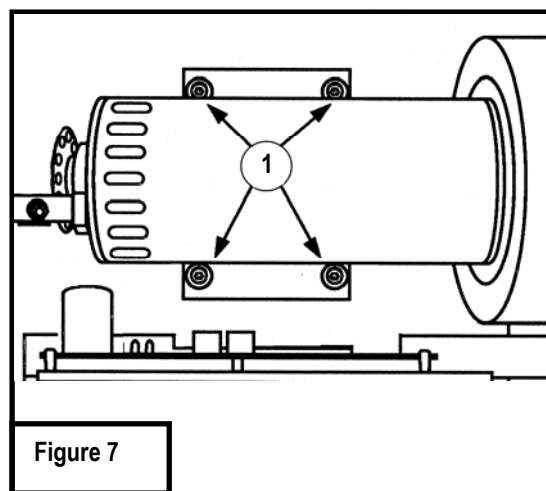

Figure 7

Continued on following page

TROUBLESHOOTING (cont'd)

Step Three: (figure 8)

Locate the drive belt adjustment screw (item 2 in fig 8) in the lower front end of the treadmill. Insert the allen wrench into the drive belt adjustment screw and turn the screw 1/2 turn clockwise.

Step Four: (figure 7)

Complete the adjustment by tightening the four motor mount screws (item 1 in fig 7).

Step Five:

Walk on the treadmill to determine if the slippage is decreased or eliminated.

Step Six:

If no improvement is observed, the hesitation may be caused by a loose tread belt - see "Tread belt tension adjustment" below. If improvement is noticed but slippage is still present, repeat steps 2 through 5. If you tighten the drive belt adjustment screw 1 1/2 turns and there is still hesitation (slippage) contact your authorized PaceMaster dealer. Tightening the drive belt adjustment screw more than 1 1/2 turns can result in bearing damage to the motor and/or drive roller.

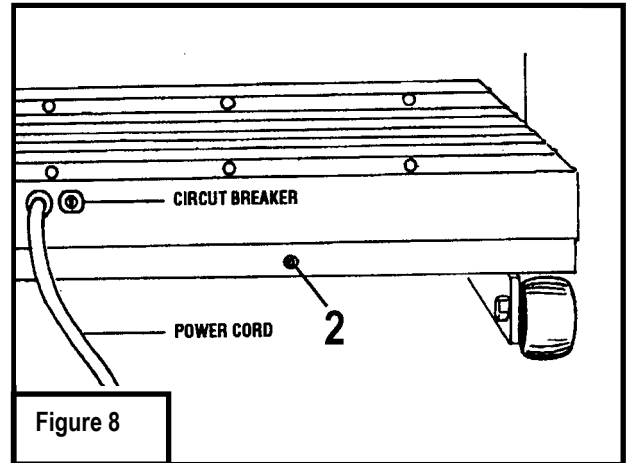

Tread Belt Tension Adjustment

Step One:

Locate the two tread belt adjustment screws (#3 & #4 in fig 9) as shown.

Step Two:

Turn both the left and right tread belt adjustment screws 1/2 turn clockwise.

Step Three:

Walk on the treadmill to see if the adjustment you made decreased the slippage.

Step Four:

If a significant decrease in slippage was observed, go to step 2. If you tighten the tread belt 1 1/2 turns per side and slippage is still present, do not continue to adjust the tread belt tension. Contact your authorized PaceMaster dealer.

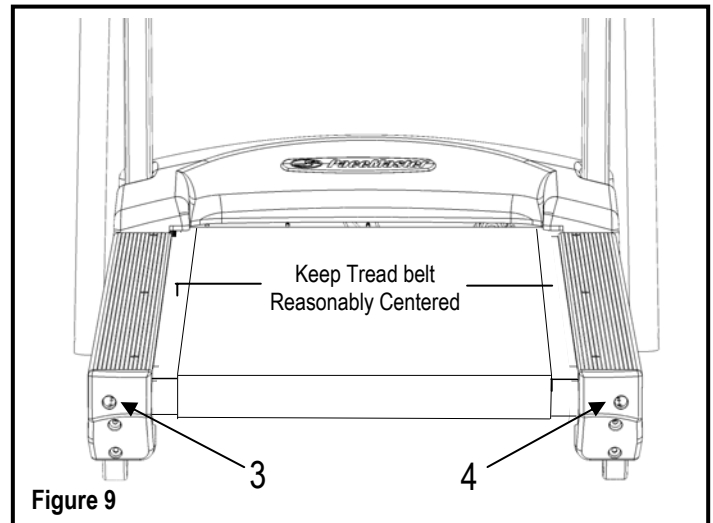

FREQUENTLY ASKED QUESTIONS

- Q.** Why is time displayed as a negative number (i.e. - 1:15)?
A. The treadmill's computer displays time in minutes and seconds (MM:SS) for workout times less than 1 Hour, and in hours and minutes (- H:MM) for workout times 1 hour or greater. - 1:15 represents one hour and 15 minutes.
- Q.** Why can't I change the speed in warm up or cool down?
A. Warm up and cool down speeds are based on parameters recommended by the American College of Sports Medicine and cannot be overridden. To avoid undue cardiovascular stress, warm up begins at a lower percentage of the workout's starting speed and gradually takes you to the workouts starting speed. Conversely, cool down gradually reduces speed based on a percentage of the workouts ending speed.
- Q.** How do I find out the total hours and miles on my treadmill?
A. Insert the magnetic safety key, when the "set weight" indicator begins to flash, press and hold the PROGRAM INTENSITY LEVEL + button the total time and mileage will appear in their respective windows and the power supply software version will appear in the INCLINE
- Q.** Can I eliminate warm up and/or cool down from a Variable Intensity Workout?
A. Yes. If you wish to remove the warm up and/or cool down phases prior to starting your workout, press the WARM UP/COOL DOWN button until the corresponding indicator light is no longer illuminated. While in the warm up mode, press the Warm Up / Cool Down button and you will advance into the main phase of your workout. While in the main workout mode press the Warm Up / Cool Down button to advance to the cool down
- Q.** Why is dust accumulating behind and/or underneath my treadmill?
A. This is normal. The dust is a combination of the PVC belt material and the phenolic deck surface as it wears.

PaceMaster Silver Select XP Technical Specifications

Boxed Dimensions	73"L x 31.5"W x 15.5" H
Assembled Dimensions	69"L x 31"W x 56"H
Boxed Weight	220 lbs.
Assembled Weight	190 lbs.
Frame	Welded aircraft grade extruded aluminum alloy
Running Surface	54"L x 20"W
Drive Motor	3.0 HP continuous duty DC
Motor Manufacturer	McMillan Electric
Motor Control	Digital PWM (Pulse Width Modulation)
Elevation Motor	1000 lb. thrust
Running Belt	Orthopedic Multi-ply polyester with static dispersing fibers, Texglide 6 lubricant.
Deck	Maintenance free custom designed medium density fiberboard
Rollers	2.5" OD precision machined steel with permanently lubricated, sealed bearings
Shock Absorption System	Tri-Flex™ Low Impact Cushioning System
Speed Range	0.5 to 11.0 mph adjustable in 0.1 mph increments
Elevation Range	0 to 15% grade adjustable in 0.5% increments
Workout Programs	Quick Start, Manual, 9 Factory Programs (each with 9 levels), 3 HRC programs
Weight Limit	300 lbs. (136 kilos)
Warranty (Residential)	Lifetime Frame, 12 Years Motor, 5 Years Parts, 1 Year Labor
Warranty (Institutional)	None
Operating Temperature Range	50° F to 100° F

Manufacturer reserves the right to change the products specifications without notice.

© Aerobics, Inc. 2009
PaceMaster is a registered trademark of Aerobics Inc.